

A Brief Literature Survey on an Automobile Air - Conditioning System

¹Jignesh K. Vaghela, ²Dr. Ragesh G. Kapadia

¹M.E. Student, ²Principal

¹Thermal Engineering, SVMIT, Bharuch-392001, Gujarat, INDIA

²Principal, SVMIT, Bharuch-392001, Gujarat, INDIA

jignesh.vaghela725@gmail.com, rag260475@gmail.com

Abstract— A Brief Literature Survey on an Automobile Air Conditioning System is presented in this paper. Various aspects related to automobile air conditioning are described here. Basic thermodynamic analysis procedure is defined. For experimental purpose, an experimental system consisting of original components from an HFC134a Automobile Air Conditioning (AAC) system has been set up. The system will be tested under steady-state operating conditions. Temperatures & pressure of the air streams entering the condenser and evaporator, compressor speed, air velocity, air humidity will be measured. From this data & analytical procedure, COP & cooling capacity will be find out for further study.

Key Words— Automobile, Automobile Air Conditioning System.

I. INTRODUCTION

• Air Conditioning [1]

According to the ASHRAE, air conditioning is the science of controlling the temperature, humidity, motion and cleanliness of the air within an enclosure. In a passenger/driver cabin of a vehicle, air conditioning means controlled and comfortable environment in the passenger cabin during summer and winter, i.e., control of temperature (for cooling or heating), control of humidity (decrease or increase), control of air circulation and ventilation (amount of air flow and fresh intake vs. partial or full recirculation), and cleaning of the air from odour, pollutants, dust, pollen, etc. before entering the cabin.

• Automobile Air Conditioning (AAC) :

Automobile Air Conditioning is the science of controlling the temperature, humidity, motion and cleanliness of the air within an automobile.

• Components of Automobile Air Conditioning:

Compressor
Condenser
Capillary Tube / Expansion Valve
Evaporator

• Functions of Automobile Air Conditioning:

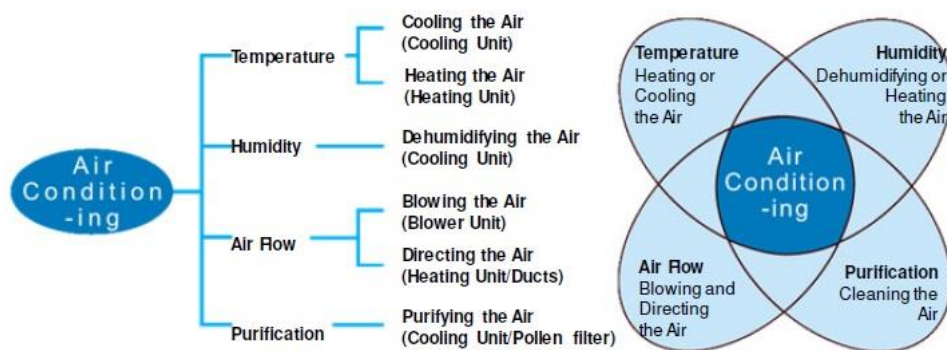

Fig 1 : Functions of Automobile Air Conditioning

• Basic Operation of Current Automotive A/C Systems [1]:

Two major types of A/C systems are used in the vehicles: Receiver Drier Thermostatic Expansion Valve (RD-TX) and Accumulator Drier Orifice Tube (AD-OT). The components and system of a typical modern RD-TXV and AD-OT systems are shown in Fig. 2 and 3 respectively. We now describe the basic operation of this system starting with the compressor. The primary function of the compressor is to compress and pressurize gaseous cool refrigerant from the evaporator outlet with minimum compressor power, and deliver maximum amount of high-pressure high-temperature gaseous refrigerant to the condenser. These objectives are measured by isentropic and volumetric efficiencies.

The compressor is powered by a drive belt from the engine. The compressor has an electrically operated engagement clutch to either turn the A/C system off or on. Next is the condenser; the condenser is located in front of the radiator. In automotive A/C systems, the condenser is typically a cross flow heat exchanger that uses air through the fins and the refrigerant through the tubes. Through the use of cool airflow provided by the engine condenser fan or ram air, the condenser cools the high-pressure hot refrigerant gas and converts it to liquid with generally a small pressure drop. The exiting liquid (subcooled in many cases) is sent via a small tube (liquid line) to a receiver-drier (RD) (applies only to an expansion valve system). The RD is a metal can with a desiccant bag inside. It is usually located near the condenser outlet pipe. Now-a-days, the RD bottle is an integral part of the condenser, and condenser is referred to as an integral receiver-drier condenser (IRDC). In this case, refrigerant passes through the RD bottle before leaving the condenser through the last pass.

Nomenclatures	
AAC	Automobile Air Conditioning
RD-TX	Receiver Drier Thermostatic Expansion Valve
AD-OT	Accumulator Drier Orifice Tube
VCR	Vapour Compression Refrigeration
COP	Coefficient Of Performance
H	specific enthalpy (kJ /kg)
h_f	specific enthalpy of the condensate (kJ/ kg)
h_g	specific enthalpy of the water vapour (kJ/ kg)
\dot{m}	mass flow rate (kg/s)
N	compressor speed (rpm)
W_c	Compressor work (kJ/kg)
q_c	Heat rejected at the condenser (kJ/kg)
q_e	Refrigerating effect / Cooling capacity (kJ/kg)
RH	Relative Humidity
S	specific entropy (kJ/kg/K)
T	Temperature (K)
V	Air Velocity (m/s)
W	specific humidity
P	Pressure (kPa)
\dot{m}_a	Mass flow rate of air (kg/s)
\dot{m}_r	Mass flow rate of refrigerant (kg/s)
c_{pa}	Specific heat of air (kJ / kg K)
(ΔT)_a	Temperature difference of air (K)
TR	Tonne of Refrigeration
\dot{V}	Volume of refrigerant (m ³ /s)
v₁	Specific volume of refrigerant at inlet of compressor (m ³ /kg)
P_c, P_e	Compressor pressure , Evaporator pressure (kPa)
T_c, T_e	Compressor temperature , Evaporator temperature(K)
P_{sat}	Saturation pressure (kPa)

The objective is to improve the degree of sub cooling of refrigerant at the condenser outlet. There is a negligible pressure/temperature change in the refrigerant through the RD bottle, except that the moisture is removed by the desiccant. The

moisture ingress in the refrigerant loop in the A/C system can internally corrode the evaporator, thermostatic expansion valve (TXV) and clog the “orifice” of the TXV if not removed.

As the high-pressure warm liquid exits the RD/condenser, it passes through an expansion device. It can be either thermostatic expansion valve (TXV) which modulates refrigerant flow in a TXV/RD system, or a fixed diameter orifice tube (OT) in an OT/AD (accumulator-drier) system.

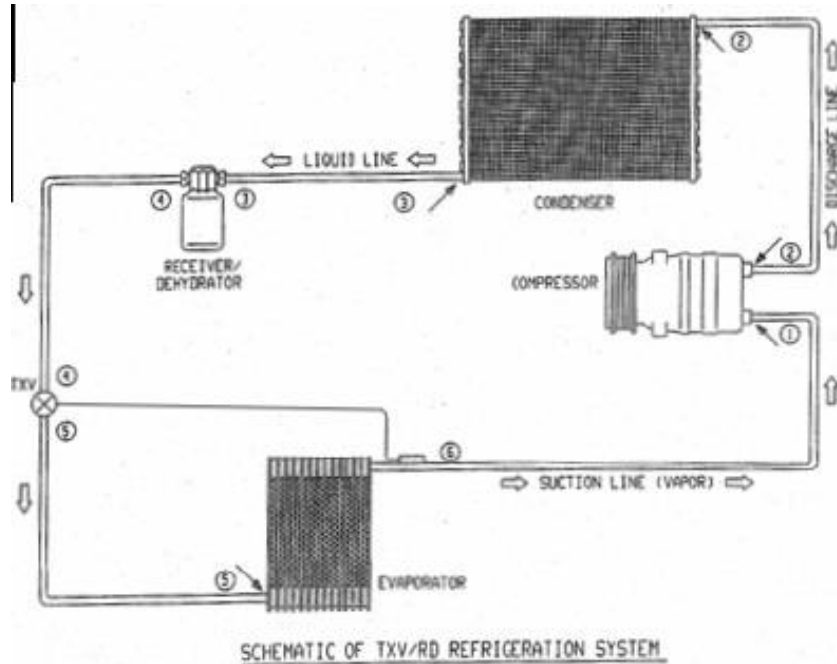

Fig 2 : TXV/RD AC System[1]

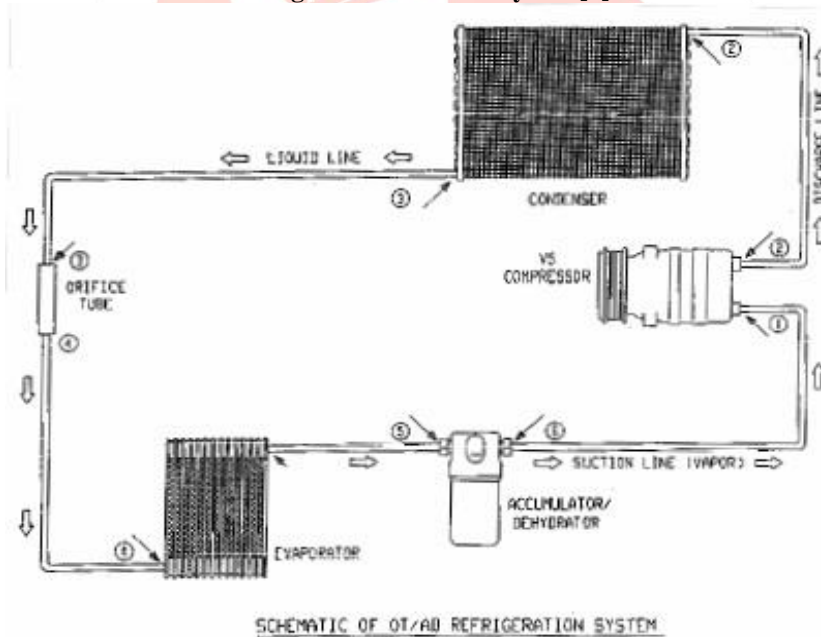

Fig 3: OT/AD AC system [1]

Effectively, the TXV has a variable diameter orifice tube and OT has a fixed diameter orifice tube. Thus TXV allows more refrigerant flow at idle compared to that for the OT thus providing higher cooling. The TXV maintains desired refrigerant superheat at the exit of the evaporator. The OT cannot control the refrigerant exit condition from the OT or evaporator. The pressurized liquid passes through the expansion device, with considerable reduction in the pressure and corresponding temperature. The cold liquid/vapour refrigerant mixture from the expansion device is fed to an evaporator in an HVAC module under the dashboard. It cools fresh or recirculated warm air, which flows into the car interior with the help of a blower. As the air is cooled in the evaporator on one fluid side, the liquid/ vapour mixture of the refrigerant is heated on the other fluid side and evaporates. The evaporated refrigerant gas then returns via the large tube (suction hose) to the compressor “suction” port to begin this whole process again [1].

II. LITERATURE SURVEY

AAC is a competitive and technology-oriented industry; the open literature on the experimental performance of AAC systems is very limited. Triggered by the Montreal Protocol, some investigators determined the performance of AAC systems using refrigerants alternative to CFC12, which was the refrigerant widely used in AAC systems until 1994.

- **Literature Survey on Substitution Of Different Alternative Refrigerants in place of R134a:**

1. **J. Steven Brown, Samuel F. Yana-Motta, Piotr A. Domanski** [2] had carried out Comparative analysis of an automotive air conditioning systems operating with CO₂ and R134a. They evaluate performance merits of CO₂ and R134a automotive air conditioning systems using semi-theoretical cycle models. The R134a system had a current-production configuration, which consisted of a compressor, condenser, expansion device, and evaporator. The CO₂ system was additionally equipped with a liquid-line/suction-line heat exchanger. Using these two systems, an effort was made to derive an equitable comparison of performance; the components in both systems were equivalent and differences in thermodynamic and transport properties were accounted for in the simulations. The analysis showed R134a having a better COP than CO₂ with the COP disparity being dependent on compressor speed (system capacity) and ambient temperature. At higher speeds and ambient temperatures, the COP disparity was even greater. The entropy generation calculations indicated that the large entropy generation in the gas cooler was the primary cause for the lower performance of CO₂.

2. **Mahmoud Ghodbane** [3] had done An Investigation of R152a and Hydrocarbon Refrigerants in Mobile Air Conditioning. Global Warming Potential (GWP) has become as important as Ozone Depletion Potential (ODP) when evaluating a potential refrigerant. Increasing concern over GWP of HFC-134a and its effect on the environment have led international heating, ventilation and air conditioning, and refrigeration (HVAC & R) industries to look at other options. This study documents an assessment of some of the options. It describes simulated performance of R152a and hydrocarbon refrigerants and their potential as alternative refrigerants to HFC-134a in mobile air conditioning systems. In addition, a comparative assessment of the performance of a secondary loop system using these refrigerants is provided. R152a have considerably less global warming impact and better transport properties than R134a. In an automotive air conditioning set up, R152a and cyclopropane (RC270) exhibit superiority as refrigerants when compared to R134a. In terms of performance, results show clearly that R152a can be regarded as an optimum substitute for R134a while cyclopropane is more than adequate. In spite of its high operating pressures, propane (R290) shows marginal improvement over the R134a baseline. The present analysis proves that isobutene (R600a) is not suitable for automotive A/C because of its low COPs and high compressor displacement requirement.

3. **S.Y.Yoo and D.W.Lee** [4] had done Experimental Study on Performance of Automotive Air Conditioning System Using R-152a Refrigerant. R-134a refrigerant is widely used in air conditioning systems because it has zero ozone depletion potential (ODP). Unfortunately, its global warming potential (GWP) is high. Therefore, alternative refrigerants are needed as a replacement for R-134a. R-152a is considered to be one of the better alternative refrigerants due to zero ODP and low GWP. In this paper, the performance of an automotive air conditioning system using R-134a and one using R-152a are compared experimentally at the bench level. The experimental apparatus simulated a real automotive air conditioning system consisting of a cabin and engine room structure. The cooling capacity, condensing capacity, coefficient of performance (COP) and power consumption characteristics of the automotive air conditioning system are evaluated by changing the air velocity entering the condenser and the compressor rotation speed with the optimized refrigerant charge amount. Also, the performance of the R-152a system was investigated by changing the thermostatic expansion valve which is set of values. The results of this study show that the R-152a system is slightly better than the R-134a system, not only under driving conditions but also under idling condition. R-152a refrigerant thus shows promise as an alternative refrigerant to replace the current standard, R-134a, in automotive air conditioning systems.

4. **Xiao Hong Han, Peng Li, Ying Jie Xu, Yu Jia Zhang, Qin Wang, Guang Ming Chen** [5] carried out cycle performances of the mixture HFC-161/HFC-134a as the substitution of HFC-134a in automotive air conditioning systems. The mixture of HFC-161/HFC-134a (0.6/0.4 in mass fraction), named 'M5', is proposed as a substitution of HFC-134a used in automotive air conditioning systems. The theoretical and experimental cycle performances for M5 and HFC-134a were conducted at the condensation temperature from 50 °C-65 °C, evaporation temperature from -5 °C to 10 °C. Theoretical results show that COP of M5 is very close to that of HFC-134a, the specific refrigeration capacity and volumetric refrigeration capacity of M5 are much higher than those of HFC-134a. Experimental results show that COP of M5 is a bit higher than that of HFC-134a, the refrigeration capacity and compressor power of M5 are about 32% and 30% higher than those of HFC-134a, respectively, the compressor discharge temperature and pressure ratio of M5 are about 15% higher and 10.9% lower than those of HFC-134a, respectively. Considering the good performance and compatibility with the existing system, M5 is a potential alternative refrigerant for HFC-134a.

5. **S. Devotta et. al** [6] has searched Alternatives to HCFC-22 for Air Conditioners. Some selected fluids have been assessed for their suitability as alternatives to HCFC-22 for air conditioners. Only those refrigerants with zero ozone depletion potential are considered. NIST CYCLE_D has been used for the comparative thermodynamic analysis. Among the refrigerants studied (HFC-134a, HC-290, R-407C, R-410A, and three blends of HFC-32, HFC-134a and HFC-125), HFC-134a offers the highest COP, but its capacity is the lowest and requires much larger compressors. The characteristics of HC-290 are very close to those of HCFC-22, and compressors require very little modification. Therefore, HC-290 is a potential candidate provided the risk concerns are mitigated as had been accomplished for refrigerators. For retrofitting, R-407C is probably the best candidate.

- **Literature Survey on Substitution Of r1234yf Refrigerant in place of r134a:**

6. Yohan Lee, Dongsoo Jung [7] carried out a brief performance comparison of R1234yf and R134a in a bench tester for automobile applications. Performance of R1234yf and R134a is examined in a heat pump bench tester under the conditions for mobile air-conditioners (MACs). Though HFC134a have been used predominantly in MACs for the past decade, it must be phased out from 2011 in new MACs in Europe due to its high global warming potential. To solve this problem, 'drop-in' tests are carried out under summer and winter conditions with R1234yf and HFC134a in a bench tester equipped with an open type compressor for MACs. Test results show that the coefficient of performance and capacity of R1234yf are up to 2.7% and 4.0% lower than those of HFC134a, respectively. The compressor discharge temperature and amount of charge of R1234yf are 6.5 °C and 10% lower than those of HFC134a. Based upon the results, it is concluded that R1234yf can be used as a long term environmentally friendly solution in MACs due to its excellent environmental properties with acceptable performance.

7. Pamela Reasor et al. [8] carried out Refrigerant R1234yf Performance Comparison Investigation. Due to environmental concerns, refrigerants with a low global warming impact are gaining importance in the refrigeration industry. Refrigerant R1234yf has a low global warming potential of 4, compared to 1430 for R134a and has thermodynamic properties similar to R134a, making it a desirable choice for future automotive refrigerants. R1234yf has a significant potential to be a drop-in replacement for R134a in the near future. Additionally, R410A is another commonly used refrigerant, and comparisons can be made between R1234yf and R410A to determine whether R1234yf has any drop-in potential for systems designed for R410A. Comparisons are made between R1234yf, R134a, and R410A, and simulations are conducted to determine the feasibility of using R1234yf as a replacement for R134a or R410A. This paper will present a comparison between the thermo physical properties of R1234yf and R134a and R410A, and will present the results of simulations using the three refrigerants in tube-fin and micro channel heat exchangers.

8. E. Navarro et al. [9] had done Comparative experimental study of an open piston Compressor working with R-1234yf, R-134a and R-290. Among the different alternatives proposed in the automotive field to replace R-134a and R-1234yf is a new generation fluid which has recently gained great importance for MAC (Mobile Air Conditioning) systems. This fluid has the advantage of having a low GWP (Global Warming potential) and thermodynamic properties similar to R-134a. But there is some criticism regarding the non-natural origin of the fluid and its possible long-term effects on the environment have not been studied. In that sense, hydrocarbons and particularly R-290 can be considered as alternatives. This paper presents a comparative study between R-1234yf, R-134a and R-290 for an open piston compressor at different operating conditions. The test matrix comprised two compressor speeds, evaporation temperatures from -15°C to 15 °C and condensation temperatures from 40°C to 65°C. From these tests, the compressor behaviour with these refrigerants has systematically been analyzed in terms of compressor efficiency, volumetric efficiency, losses to the ambient and oil-refrigerant properties.

9. J. Navarro et al. [10] performed Experimental analysis of R1234yf as a drop-in replacement for R134a in a vapour compression system. This paper presents an experimental analysis of a vapour compression system using R1234yf as a drop-in replacement for R134a. In this work, we compare the energy performance of both refrigerants, R134a and R1234yf, in a monitored vapour compression system under a wide range of working conditions. So, the experimental tests are carried out varying the condensing temperature, the evaporating temperature, the superheating degree, the compressor speed, and the internal heat exchanger use. Comparisons are made taking refrigerant R134a as baseline, and the results show that the cooling capacity obtained with R1234yf in a R134a vapour compression system is about 9% lower than that obtained with R134a in the studied range. Also, when using R1234yf, the system shows values of COP about 19% lower than those obtained using R134a, being the minor difference for higher condensing temperatures. Finally, using an internal heat exchanger these differences in the energy performance are significantly reduced.

10. Honghyun Cho et al. [11] Work on Performance characteristics of an automobile air conditioning system with internal heat exchanger using refrigerant R1234yf. In this study, performance was assessed by charging the same automotive refrigeration systems with the refrigerants R134a and R1234yf, respectively, to compare the characteristics of the refrigeration cycle of the two refrigerants. The internal heat exchanger was installed in order to improve cooling performance of R1234yf and to investigate the level of performance improvement in comparison with conventional R134a system. Performance test by using R1234yf and R134a in the same system showed low power consumption and cooling capacity for using R1234yf, that is, up to 4% and 7%. In particular, performance comparison between the R1234yf and R134a for automotive air conditioning revealed that cooling capacity and COP of the 1234yf system without the IHX decreased by up to 7% and 4.5%, respectively, but those with the IHX decreased by up to 1.8% and 2.9%, respectively.

11. Francisco Moles et al. [12] Experimental analysis of the internal heat exchanger influence on a vapour compression system performance working with R1234yf as a drop-in replacement for R134a. This paper presents an experimental analysis of the influence of an internal heat exchanger on the performance of a vapour compression system using R1234yf as a drop-in replacement for R134a. In this work, we compare the energy performance of a monitored vapour compression system using both refrigerants, R134a and R1234yf, with and without the presence of an internal heat exchanger under a wide range of working conditions. A set of experimental tests are carried out varying the condensing temperature, the evaporating temperature and the internal heat exchanger use. From the experimental results, reductions in cooling capacity and COP between 6 and 13% have been observed when R134a is replaced by the drop-in fluid R1234yf, although the presence of an IHX can help to lessen these reductions

between 2 and 6%. Finally, the experimental results obtained agree with the theoretical evaluations developed neglecting the pressure drops.

- **Literature Survey on Energy & Exergy Analysis of AAC :**

12. Dilek Ozlem ESEN, Murat HOSOZ [13] performed Energy and Exergy Analysis of an Automobile Air Conditioning System Using Refrigerant R134a. This paper deals with the energy and exergy analysis of automobile air conditioning (AAC) system to apply the performance of an AAC system using R134a ($C_2H_2F_4$ / Tetrafloretan) as the refrigerant. Exergy and energy analysis of separate components of AC system have been carried out under various operating conditioning. Exergy and energy analysis show that the performance of the system degrades with increasing compressor speed. The coefficient of performance (COP) for R134a system is lower than that for different compressor speed for the same cooling capacity. Furthermore, the COP increases with increasing evaporator load and decreases with increasing compressor speed and condensing temperature. The rate of exergy destruction in each component of the AAC system has been found. Exergy destruction increases with increasing compressor speed in the compressor, condenser, evaporator and TXV. The component with the greatest increase in exergy destruction as a result of compressor speed is the compressor itself.

- **Literature Survey on AAC with Variable Capacity Compressor :**

13. Alpaslan Alkan, Murat Hosoz [14] performed Comparative performance of an automotive air conditioning system using fixed and variable capacity compressors. This study investigates the experimental performance of an automotive air conditioning (AAC) system for the cases of employing fixed and variable capacity compressors (FCC and VCC). For this aim, an experimental system consisting of original components from an HFC134a AAC system has been set up and instrumented. For each compressor case, the system has been tested under steady-state operating conditions by varying the compressor speed, temperatures of the air streams entering the condenser and evaporator as well as the velocities of these air streams. The energy and exergy analysis has been applied to the experimental system, and its performance for both compressor operations has been evaluated. The results show that the operation with the VCC usually yields a higher COP than the operation with the FCC in expense of a lower cooling capacity. Furthermore, the cooling capacity and the rate of total exergy destruction in the VCC operations remain almost constant after a certain compressor speed, while both parameters increase continually with the compressor speed in the FCC operations.

14. J.M. Saiz Jabardo, W. Gonzales Mamani, M.R. Ianella [15] had done Modelling and experimental evaluation of an automotive air conditioning system with a variable capacity compressor. A steady state computer simulation model has been developed for refrigeration circuits of automobile air conditioning systems. The simulation model includes a variable capacity compressor and a thermostatic expansion valve in addition to the evaporator and micro channel parallel flow condenser. An experimental bench made up of original components from the air conditioning system of a compact passenger vehicle has been developed in order to check results from the model. The refrigeration circuit was equipped with a variable capacity compressor run by an electric motor controlled by a frequency converter. Effects on system performance of such operational parameters as compressor speed, return air in the evaporator and condensing air temperatures have been experimentally evaluated and simulated by means of developed model. Model results deviate from the experimentally obtained within a 20% range though most of them are within a 10% range. Effects of the refrigerant inventory have also been experimentally evaluated with results showing no effects on system performance over a wide range of refrigerant charges. Conclusions made are: 1 The COP is always affected negatively by increments in the particular parameter. In the case of the refrigerant charge, this effect is only significant under overcharged conditions. 2. Variable parameters during the operation of the vehicle such as the condensing air temperature and compressor speed do not affect the refrigerating capacity. This is certainly due to the action of the capacity control mechanism of the compressor. 3. The refrigerating capacity is significantly affected by the evaporator return air temperature. It has been determined that the compressor capacity control device can accommodate a significant range of thermal loads even those associated to return temperatures higher than the ones in the typical range (from 20 to 30°C). 4. Refrigerating capacity, mass flow rate and COP vary linearly with condensing and return air temperatures and compressor speed. Slight deviations from linear behaviour have been found at low refrigerating capacities.

15. Changqing Tian, Yunfei Liao, Xianting Li [16] developed a mathematical model of variable displacement swash plate compressor for automotive air conditioning system. A mathematical model of control mechanism used in the variable displacement swash plate compressor (VDSC) is developed firstly based on the force balance equation, mass and energy conservation equation. The model of moving components dynamics is developed then by analyzing the forces and force moments acting on the pistons and the swash plate. The compression process model is obtained by fitting the data from our experiments. And finally, the steady-state mathematical model of VDSC is developed by combining the three sub-models above. In order to verify the mathematical model, a test bench for control mechanism and the test system for VDSC have been established, and the simulated results agree well with the experimental data. The simulation results show that, like the variable displacement wobble plate compressor, there are four operation modes for the VDSC, i.e. constant rotary speed and constant piston stroke length (PSL), variable rotary speed and constant PSL, constant rotary speed and variable PSL, variable rotary speed and variable PSL, which have included almost all operation modes of the refrigeration compressor in common use. There is a hysteresis zone and multiple-valued relationship between the compressor parameters when PSL changes.

- **Literature Survey on Simulation & Modelling of AAC:**

In addition to the studies on the experimental performance of AAC systems with alternative refrigerants & variable capacity compressor, some investigators simulated AAC systems.

16. G.H. Lee, J.Y. Yoo [17] carried out Performance analysis and simulation of automobile air conditioning system under various operating conditions. The air conditioning system consists of a laminated type evaporator, a swash plate type compressor, a parallel flow type condenser, a receiver drier and an externally equalized thermostatic expansion valve. A computer program for performance analysis of the laminated type evaporator has been developed on the basis of the overall heat transfer coefficient and pressure drop which were obtained experimentally. A computer program for performance analysis of the parallel flow type condenser, using an empirical equation for the heat transfer coefficient, has been developed, which demonstrates that the predicted condensing capacity agrees very well with the experimental data. Then, a model for combining the performance analysis programs of separate components of an automobile air conditioning system is proposed, which simulates very well the performance of the integrated automobile air conditioning system. Further, the effects of condenser size and refrigerant charge on the performance of the integrated automobile air conditioning system are discussed. The following conclusions have been drawn from the performance simulation of the integrated air conditioning system: 1. An overcharge of 10% proves to be most effective for various operating conditions. With an over-charge above this level, the COP rather tends to drop. 2. It is possible to select the most appropriate condenser size by executing the system performance simulation program for various operating conditions. 3. The agreement between the simulation results and experimental ones was within 7%.

17. Terry J. Hendricks [18] had done Optimization of Vehicle Air Conditioning Systems Using Transient Air Conditioning Performance Analysis. The National Renewable Energy Laboratory (NREL) has developed a transient air conditioning (A/C) system model using SINDA/FLUINT analysis software. It captures all the relevant physics of transient A/C system performance, including two-phase flow effects in the evaporator and condenser, system mass effects, air side heat transfer on the condenser/evaporator, vehicle speed effects, temperature-dependent properties, and integration with a simplified cabin thermal model. It has demonstrated robust and powerful system design optimization capabilities. Single-variable and multiple variable design optimizations have been performed and are presented. Various system performance parameters can be optimized, including system COP, cabin cool down time, and system heat load capacity. This work presents this new transient A/C system analysis and optimization tool and shows some high-level system design conclusions reached to date. The work focuses on R-134a A/C systems, but future efforts will modify the model to investigate the transient performance of alternative refrigerant systems such as carbon dioxide systems. NREL is integrating its transient air conditioning model into NREL's ADVISOR vehicle system analysis software, with the objective of simultaneously optimizing A/C system designs within the overall vehicle design optimization.

18. Haslinda Mohamed Kamar, Robiah Ahmadb, N.B. Kamsah & Ahmad Faiz Mohamad Mustafa [19] had studied Artificial neural networks for automotive air-conditioning systems for performance prediction. In this study, ANN model for a standard air-conditioning system for a passenger car was developed to predict the cooling capacity, compressor power input and the coefficient of performance (COP) of the automotive air-conditioning (AAC) system. This paper describes the development of an experimental rig for generating the required data. The experimental rig was operated at steady-state conditions while varying the compressor speed, air temperature at evaporator inlet, air temperature at condenser inlet and air velocity at evaporator inlet. Using these data, the network using Lavenberge- Marquardt (LM) variant was optimized for 4-3-3 (neurons in input-hidden-output layers) configuration. The developed ANN model for the AAC system shows good performance with an error index in the range of 0.65 - 1.65%, mean square error (MSE) between 1.09×10^{-5} and 9.05×10^{-5} and the root mean square error (RMSE) in the range of 0.33-0.95%. Moreover, the correlation which relates the predicted outputs of the ANN model to the experimental results has a high coefficient in predicting the AAC system performance.

19. Murat HOSOZ, Alpaslan ALKAN & H. Metin ERTUNC [20] were performed Modelling of an Automotive Air Conditioning System Using ANFIS. This study deals with modelling the performance of an R134a automobile air conditioning (AAC) system by means of Adaptive Neuro-Fuzzy Inference System (ANFIS) approach. In order to gather data for developing the ANFIS model, an experimental AAC system employing a variable capacity swash plate compressor and a thermostatic expansion valve was set up and equipped with various instruments for mechanical measurements. The system was operated at steady state conditions while varying the compressor speed, dry bulb temperatures and relative humidity of the air streams entering the evaporator and condenser as well as the mean velocities of these air streams. Then, utilizing some of the experimental data, an ANFIS model for the system was developed. The model was used for predicting various performance parameters of the system including the air dry bulb temperature at the evaporator outlet, cooling capacity, coefficient of performance and the rate of total exergy destruction in the refrigeration circuit of the system. It was determined that the predictions usually agreed well with the experimental results with correlation coefficients in the range of 0.966–0.988 and mean relative errors in the range of 0.23–5.28%. The results reveal that the ANFIS approach, which is a powerful fuzzy logic neural network, can be used successfully for predicting the performance of AAC systems.

- **Literature Survey on some performance enhancement strategies for AAC :**

20. M. S. Bhatti [21] studied potential augmentation of the AAC systems with HFC134a to lower its global warming impact. His "Enhancement of R-134a Automotive Air Conditioning System" paper deals with potential augmentation of the present R134a

automotive air conditioning system with the intent to lower its Total Equivalent Warming Impact (TEWI) which is a source of concern from the standpoint of environmental benignity of the system. It is identified that the most effective augmentation strategy includes (1) increase in compressor isentropic efficiency, (2) increase in condenser effectiveness, (3) decrease in lubricant circulation through the system, (4) decrease in air side pressure drop in evaporator through improved condensate management, (5) increase in condenser airflow, (6) decrease in air conditioning load via permissible increase in the amount of recirculated air through the passenger compartment and (7) reduction in direct emission of R-134a from the system through conservation and containment measures. The effect of each of these augmentations on the coefficient of performance (COP) of the system is quantified in a rigorous fashion. Extensive results are presented pertaining to performance of the present baseline R-134a system, realistically enhanced R-134a system and the idealized R-134a system that gives an upper bound on the maximum possible augmentation from a thermodynamic point of view. The paper also provides extensive comparisons of the TEWI of the R-134a system with those of the proposed alternate systems, viz., the flammable subcritical systems (R-152a, R-290 and R-717), supercritical carbon dioxide (R-744) system and conventional open air (R-729) cycle system. Based on these comparisons, it is concluded that the enhanced R-134a system is the most pragmatic solution to deal with the issue of the automotive air conditioning system TEWI.

21. Zhaogang Qi, Yu Zhao & Jiangping Chen [22] had done Performance Enhancement Study Of Mobile Air Conditioning System Using Microchannel Heat Exchangers. In the present paper, two retrofitted compact and high efficient micro channel heat exchangers were proposed. The new micro channel heat exchangers have advantages in compactness (17.2% and 15.1% volume reduction for evaporator and condenser, respectively), weight (2.8% and 14.9% lighter for evaporator and condenser, respectively), heat transfer characteristics compared with the currently used heat exchangers in mobile air conditioning (MAC) industry. One enhanced and one baseline R134a MAC systems were established including the new micro channel heat exchangers and the traditional MAC heat exchangers, respectively. The system performances have been experimentally carried out under variable ambient conditions in psychrometric calorimeter test bench. The optimal system refrigerant charge amounts for both systems were tested and the results showed that the enhanced system with more compact heat exchangers could reduce system charge amount and the minimum effective charge amount was less than that of the baseline system. The enhanced system could supply more cooling capacity to car compartment under all test conditions because of higher performance heat exchangers. The coefficient of performance (COP) of the enhanced system was slightly lower than that of the baseline system under idle conditions but higher under all the other test conditions. Cooling capacity and COP of the enhanced system was increased by about 5% and 8% under high vehicle speed condition.

- **Literature Survey on Suction Line Heat Exchanger for r134a AAC :**

22. M. Preissner et al. [23] Work on Suction Line Heat Exchanger for R134A Automotive Air-Conditioning System. The performance of an R134a automotive prototype air conditioning system was tested in the laboratory with and without an internal heat exchanger. At a higher condenser air temperature of 40°C and a restrictive idling air flow rate of 1.0 m/s, the COP and the capacity increased on the order of 5 to 10 % with a suction line heat exchanger with 60 % effectiveness. If the system is operated not at the optimum expansion device setting or it is undercharged, the improvement in system performance is even higher. When designing a suction line heat exchanger, the low side pressure drop is critical and must be minimized so as not to compensate the performance improvement.

III. FINDINGS FROM LITERATURE SURVEY:

- Refrigerant R134a having a better COP than CO₂.
- R152a and cyclopropane (RC270) exhibit superiority as refrigerants when compared to R134a. For retrofitting, R-407C & R-410A are also the good candidate but some modification in the system is necessary.
- The mixture of HFC-161/HFC-134a (0.6/0.4 in mass fraction), named 'M5' is a potential alternative refrigerant for HFC-134a.
- Refrigerant R1234yf can be used as a long term environmentally friendly solution in AAC due to its excellent environmental properties with acceptable performance. Performance comparison between the R1234yf and R134a for automotive air conditioning revealed that cooling capacity and COP of the 1234yf system without the IHX decreased by up to 7% and 4.5%, respectively, but those with the IHX decreased by up to 1.8% and 2.9%, respectively.
- Exergy and energy analysis show that the performance of the system degrades with increasing compressor speed.
- Operation with Variable Capacity Compressor usually yields a higher COP than the operation with the Fixed Capacity Compressor in expense of a lower cooling capacity.
- With the use of suction line heat exchanger in automobile ac, the COP and the capacity are increased on the order of 5 to 10 % at a higher condenser air temperature of 40°C and a restrictive idling air flow rate of 1.0 m/s compared to automobile ac without suction line heat exchanger.

IV. EXPERIMENTAL SET-UP:

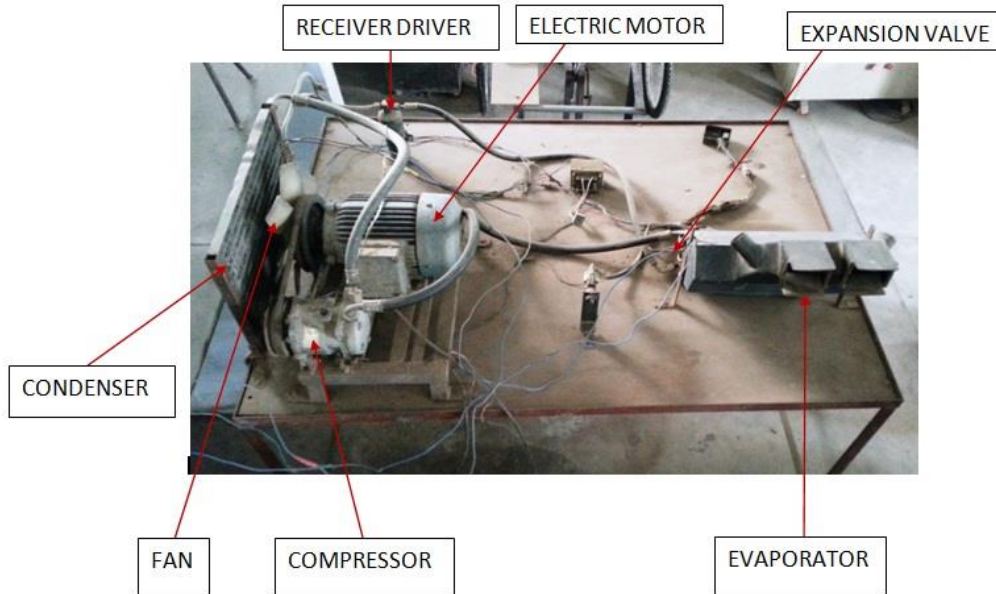

Fig 4: Experimental Set-Up

The experimental Automobile AC system mainly consists of the original components from an HFC134a automobile air conditioning system, as shown in Fig. 4. Moreover, it requires some auxiliary equipment used for testing the system under the required conditions and some instruments used for performing mechanical measurements. The refrigeration circuit of the system consists of compressor, condenser, liquid receiver, expansion valve & evaporator.

The experimental system contains fan driven by an electric motor. The compressor in the experimental system is belt driven by an electric motor, which allows the operation of the compressors at the required speed. The air flow passing through the condenser can be achieved by fan. Condenser is air cooled & plate fin type. The air flow rate passing through the evaporator can be maintained at the required value by varying the voltage via a voltage regulator.

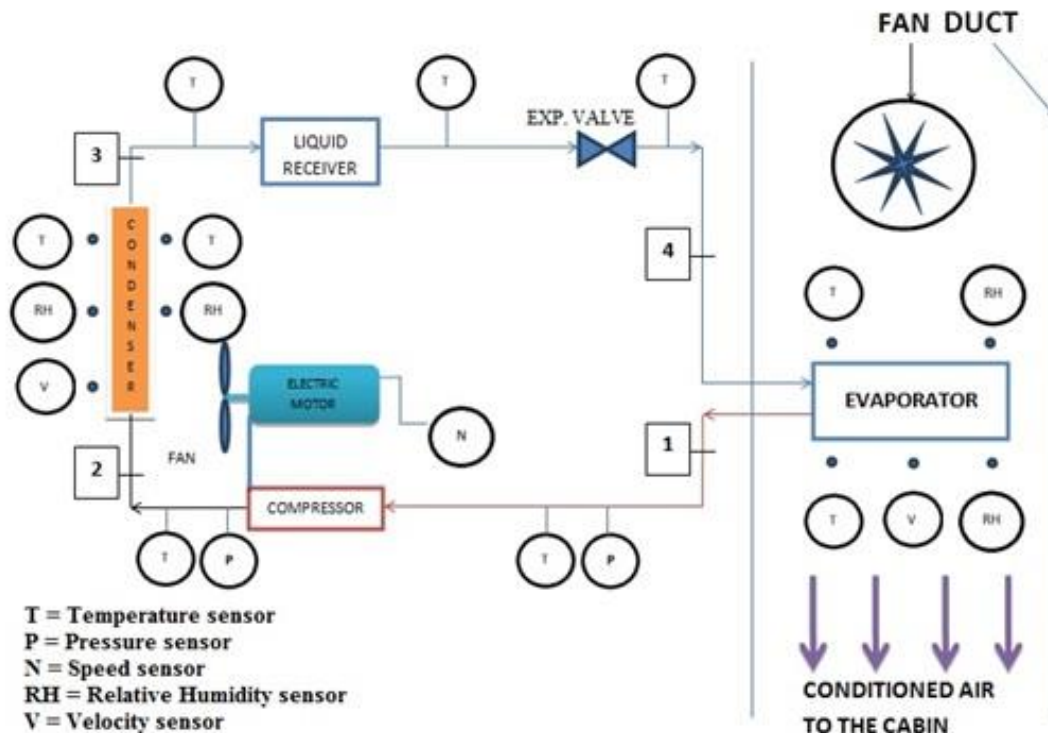

Fig 5: Schematic diagram of Experimental AAC system

The locations and types of the measurements are depicted in Fig.5. The refrigerant temperatures will be detected by the thermocouples soldered to the tube. The dry bulb temperatures and relative humidities of the air streams entering and leaving the evaporator and condenser will be measured. The suction and discharge pressures of the compressor will be measured by Bourdon

tube gauges. Neglecting the pressure drops in the evaporator and condenser as well as in the connecting lines, it is assumed that the evaporating and condensing pressures is equal to the measured suction and discharge pressures, respectively. The compressor speed will be measured by a photoelectric tachometer. The air velocity at the outlet of the evaporator & condenser will be measured by an anemometer. Then, the air mass flow rates passing through the evaporator and condenser will be determined from the product of the air density by the air velocity and the flow area. Some features of the instrumentation are summarized in Table 1.

Characteristics Of Instrumentation		
Measured variable	Instrument	Range
Temperature	Type K thermocouple	0/100 °C
Pressure	Bourdon gauge	-100/1000 and 0/3000 kPa
Relative humidity	Hygrometer	10/100%
Compressor speed	Photoelectric tachometer	10/100,000 rpm
Air velocity	Anemometer	0.1/15 ms ⁻¹

Table 1: Characteristics of Instrumentation [14]

V. BASIC THERMODYNAMIC ANALYSIS PROCEDURE:

Automobile AC system works on Vapour Compression Refrigeration (VCR) cycle. The representation of cycle on schematic, (T-s) & (p-h) diagram is shown in fig 6, 7 & 8 respectively when the vapour at the end of compression is assumed to be dry-saturated.

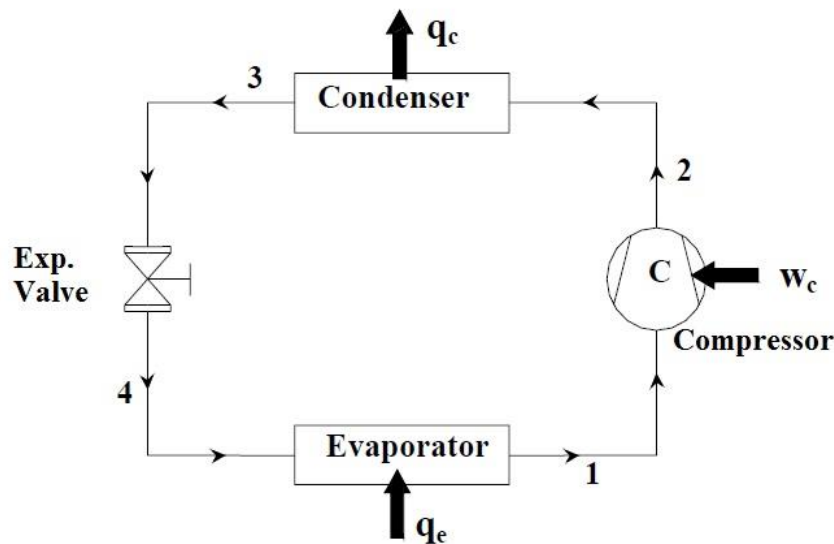

Fig. 6: Schematic Diagram of VCR [24]

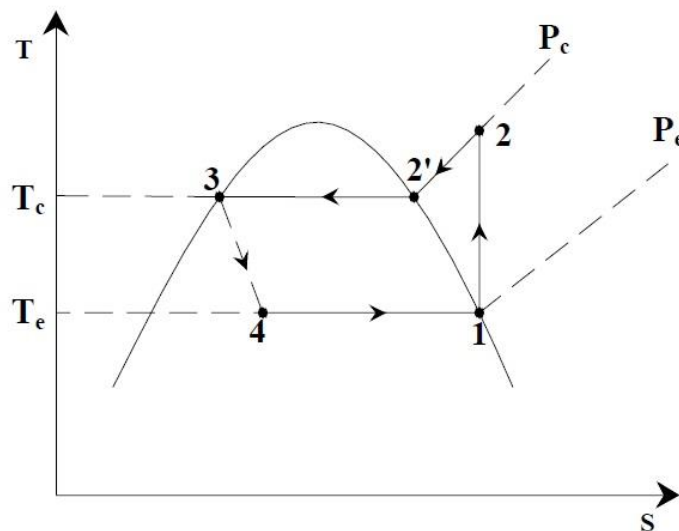

Fig. 7: T-s diagram of VCR [24]

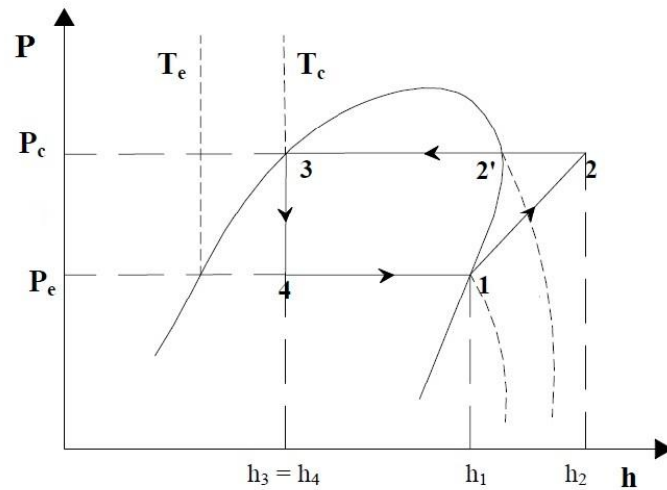

Fig. 8: P-h diagram of VCR [24]

Assuming that 1 kg of refrigerant flows in the system, we can analyse the system as follows with help of steady flow energy equation. Thermodynamic analysis is as follows [24].

(a) Compressor work, W_c :

$$W_c = h_2 - h_1, \text{ kJ/kg}$$

Compressor pressure, $P_c = P_{\text{sat}}(T_c)$

(b) Heat rejected at the condenser, q_c :

$$q_c = h_2 - h_3, \text{ kJ/kg}$$

(c) Expansion device:

$$h_3 = h_4, \text{ kJ/kg}$$

$$h_{f3} = h_{f4} + x_4 h_{fg4}$$

where, h_{f3} = enthalpy of liquid at condenser pressure p_c

h_{f4} = enthalpy of liquid at evaporator pressure p_e

h_{fg4} = enthalpy of evaporation at evaporator pressure p_e

x_4 = dryness fraction of vapour after throttling

(d) Refrigerating effect / Cooling capacity, q_e :

$$q_e = h_1 - h_4, \text{ kJ/kg}$$

Evaporator pressure, $P_e = P_{\text{sat}}(T_e)$

(e) COP:

$$\text{COP} = \frac{\text{Cooling capacity, } q_e}{\text{Compression work, } w_c} = \frac{h_1 - h_4}{h_2 - h_1}$$

(f) Cooling air required at condenser:

Heat given away by refrigerant = Heat absorbed by cooling air

$$\dot{m}_r (h_2 - h_1) = \dot{m}_a * c_{pa} * (\Delta T)_a$$

(g) Compressor Power, P :

$$P = \dot{m}_r (h_2 - h_1), \text{ kW}$$

(h) Mass of refrigerant to be circulated, \dot{m}_r per tonne of refrigeration:

Since 1 TR = 3.517 kJ/s

$$\therefore \dot{m}_r = \frac{3.517 \text{ (kJ/s)}}{q_e \text{ (kJ/kg)}} \text{ kJ/s/TR}$$

(i) Volume of refrigerant to be handled by compressor per TR:

$$\dot{V} = \dot{m}_r * v_1, \text{ m}^3/\text{s}$$

VI. CONCLUSIONS

In this paper, a brief literature survey on an Automobile Air Conditioning System is presented. From literature survey, different findings are concluded. Basic thermodynamic analysis procedure is defined. For experimental purpose, a system consisting of original components from an HFC134a AAC system has been set up. Different parameters like temperatures & pressure of the air streams entering the condenser and evaporator, compressor speed, air velocity, air humidity will be measured. From this data & analytical procedure, COP & cooling capacity will be find out for further study. The result of this study can be used by HVAC engineers to design more efficient automobile AC systems.

ACKNOWLEDGMENTS

The authors would like to thank SVMIT, Bharuch for their valuable input during the course of this investigation.

REFERENCES

- [1] R.K. Shah, "Automotive air-conditioning systems – historical developments, the state of technology and future trends", Proceedings of the 3rd BSME-ASME International Conference on Thermal Engineering, 20-22 December 2006, Dhaka, Bangladesh
- [2] J. Steven Brown, Samuel F. Yana-Motta, Piotr A. Domanski, "Comparative analysis of an automotive air conditioning systems operating with CO₂ and R134a", International Journal of Refrigeration 25 (2002) 19–32
- [3] Ghodbane M., "An Investigation of R152a and Hydrocarbon Refrigerants in Mobile Air Conditioning", SAE Paper, Paper No. 1999-01-0874.
- [4] S.Y. YOO and D.W. LEE, "Experimental Study On Performance Of Automotive Air Conditioning System Using R-152a Refrigerant", International Journal of Automotive Technology, Vol. 10, No. 3, pp. 313–320 (2009).
- [5] Xiao Hong Han, Peng Li, Ying Jie Xu, Yu Jia Zhang, Qin Wang, Guang Ming Chen, "Cycle performances of the mixture HFC-161/HFC-134a as the substitution of HFC-134a in automotive air conditioning systems" International Journal of Refrigeration 36 (2013) 913-920
- [6] S. Devotta, A.V. Waghmare, N.N. Sawant, B.M. Domkundwar, "Alternatives to HCFC-22 for air conditioners", Applied Thermal Engineering 21 (2001) 703-715
- [7] Yohan Lee, Dongsoo Jung, "A brief performance comparison of R1234yf and R134a in a bench tester for automobile applications", Applied Thermal Engineering 35 (2012) 240-242
- [8] Pamela Reasor, Vikrant Aute, Reinhard Radermacher, "Refrigerant R1234yf Performance Comparison Investigation", International Refrigeration and Air Conditioning Conference, Purdue University, Purdue e-Pubs.
- [9] E. Navarro, I.O. Martinez, J. Nohales, J. Gonzalez-Macia, "Comparative experimental study of an open piston compressor working with R-1234yf, R-134a and R-290", International Journal of Refrigeration, 36 (2013) 768-775
- [10] J. Navarro, J.M. Mendoza, A. Mota-Babiloni, A. Barragan, J.M. Belman, "Experimental analysis of R1234yf as a drop-in replacement for R134a in a vapour compression system", International Journal of Refrigeration, 36 (2013) 870-880
- [11] Honghyun Cho, Hoseong Lee, Chasik Park, "Performance characteristics of an automobile air conditioning system with internal heat exchanger using refrigerant R1234yf", Applied Thermal Engineering 61 (2013) 563-569
- [12] Joaquin Navarro, Francisco Moles, Angel Barragan, "Experimental analysis of the internal heat exchanger influence on a vapour compression system performance working with R1234yf as a drop-in replacement for R134a", Applied Thermal Engineering 59 (2013) 153-161
- [13] Dilek Ozlem ESEN, Murat HOSOZ, "Energy And Exergy Analysis Of An Automobile Air Conditioning System Using Refrigerant R134a", (2007) ISSN 1012-2354
- [14] Alpaslan Alkan, Murat Hosoz, "Comparative performance of an automotive air conditioning system using fixed and variable capacity compressors", International Journal of Refrigeration 33 (2010) 487–495
- [15] Jabardo, J.M.S., Mamani, W.G., Ianella, M.R., 2003. "Modelling and experimental evaluation of an automotive air conditioning system with a variable capacity compressor" International Journal of Refrigeration 25, 1157–1173.
- [16] Tian, C., Liao, Y., Li, X., 2006, "A mathematical model of variable displacement swash plate compressor for automotive air conditioning system", International Journal of Refrigeration 29, 270–280.
- [17] G.H. Lee, J.Y. Yoo, "Performance analysis and simulation of automobile air conditioning system", International Journal of Refrigeration 23 (2000) 243-254
- [18] Terry J. Hendricks, "Optimization of Vehicle Air Conditioning Systems Using Transient Air Conditioning Performance Analysis.", National Renewable Energy Laboratory 2001-01-1734
- [19] H.M Kamar, R. Ahmadb, N.B. Kamsah & A F M Mustafa, "Artificial neural networks for automotive air-conditioning systems for performance prediction" Applied Thermal Engineering 50 (2013) 63-70
- [20] Murat HOSOZ, Alpaslan ALKAN & H. Metin ERTUNC, "Modelling Of An Automotive Air Conditioning System Using ANFIS", J. of Thermal Science and Technology, 2013, ISSN 1300-3615
- [21] Bhatti, M.S., 1999, "Enhancement of R-134a automotive air conditioning system", SAE Paper, Paper No. 1999-01-0870.
- [22] Zhaogang Qi, Yu Zhao & Jiangping Chen, "Performance Enhancement Study Of Mobile Air Conditioning System Using Microchannel Heat Exchangers", International Journal of Refrigeration 33(2010)301 –312

- [23] M. Preissner, B. Cutler, R. Radermacher, C. A. Zhang, "Suction Line Heat Exchanger for R134A Automotive Air-Conditioning System", International Refrigeration and Air Conditioning, Purdue University Purdue e-Pubs
- [24] <http://nptel.iitk.ac.in/courses/Webcoursecontents/IIT%20Kharagpur/Ref%20and%20Air%20Cond/pdf/RAC%20Lecture%2010.pdf>

