

Investigation and Thermal Analysis of Heat Dissipation Rate of Single Cylinder SI Engine

Sandeep Kumar¹, Prof. Nitin Dubey²

¹M.Tech Research Scholar All Saints College of Technology, Bhopal (M.P) India

² Prof. Department of ME All Saints College of Technology, Bhopal (M.P) India

Abstract:

The energy transfer from the combustion chamber of an internal combustion engines are dissipate in three different ways. About 35 % of the fuel energy is converted into useful crankshaft work and about 30 % energy is expelled to the exhaust. From the few decades there has been an increasing demand for improving IC engines in terms of exhaust emissions, fuel consumption, power and efficiency. because of increasing fuel prices and growing environmental concern in modern society. The aim of present work to increase heat transfer rate from the heating zone in IC engine, for that transient thermal analysis have been performed on actual design of bajaj discover 125 CC single cylinder engine. Transient thermal analyses were performed for actual and proposed design of engine cylinder in order to optimize geometrical parameters and enhanced heat transfer from the IC engine. Result revel that the proposed design -2 of IC engine has better performance and heat transfer rate from the heating zone in the IC engine that is why the result of present work is more concentrate on it and also proposed replacement of new design.

Key words: Internal Combustion engine, transient thermal analysis, engine performance, Heat transfer rate etc.

1. Introduction:

The energy transfer from the combustion chamber of an internal combustion engines are dissipate in three different ways. About 35 % of the fuel energy is converted into useful crankshaft work and about 30 % energy is expelled to the exhaust. About one third of the total heat generated during the combustion process must be transmitted from the combustion chamber through the cylinder walls and cylinder head to the atmosphere.

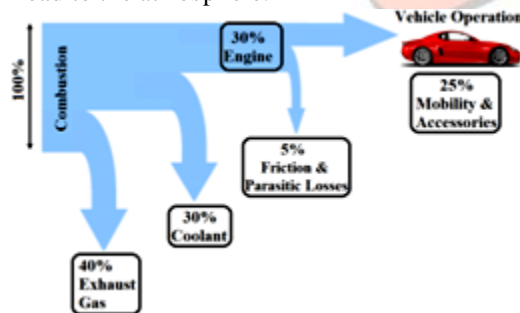

Figure 1: Typical energy path in internal combustion engine vehicle

Modes of Heat Transfer IC engine: conduction: In this process heat is transferred by molecular motion through solids and through fluids at rest due to a temperature gradient. The heat transfer by conduction per unit area per unit time "q" in a steady situation is given by Fourier's law:

$$q = -KVT$$

Heat transfer by convection in the inlet system is used to raise the temperature of the incoming charge. Heat is also transfer from the engine to the environment by convection process.

$$q = h_c(T - T_w)$$

The hypothesis of heat transfer due to radiation initiates from the concept of "black body". The heat flux from black body at temperature T_1 to another at temperature T_2 parallel to it across a space containing no absorbing material is given by:

$$q = \sigma(T_1^4 - T_2^4)$$

Heating the Manifolds: Intake manifold is the part of an IC engine that supplies the air-fuel mixture to the engine cylinder.

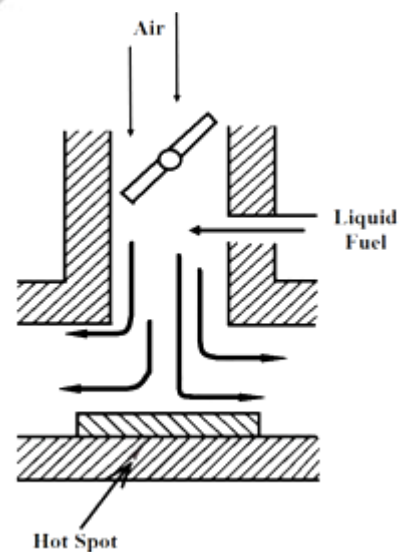

Figure 2: Air fuel intake system

Heat Transfer in Intake System: Heat transfer by convection:

$$Q = hA(T_{wall} - T_{gas})$$

Heat Transfer in Combustion Chambers: During combustion process highest gas temperatures occur around the spark plug as shown in figure 1.3

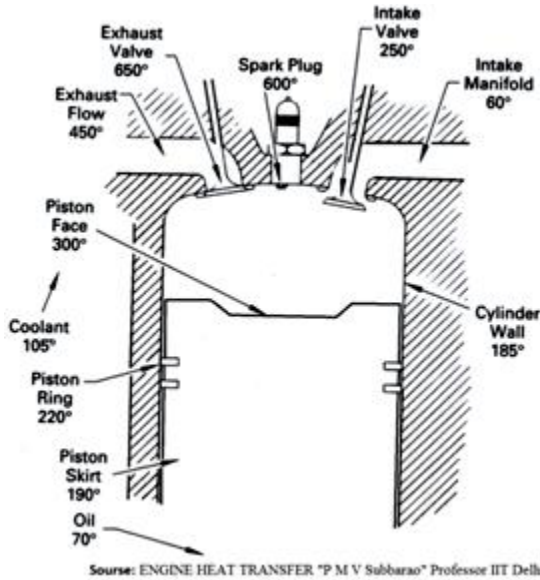

Figure 3: Temperature Distribution in Combustion Chambers

During combustion process highest gas temperatures occur around the spark plug as shown in figure 1.3 in this figure three hottest points identified the first one is exhaust valve, second is exhaust flow pipe and third is face of the piston which creates a critical heat transfer problem. The exhaust valve is very hot about 650 °C as shown in above because it is opening for hot exhaust gases, these hot gases passes from exhaust manifold and liberated to atmosphere.

2. Literature Review:

Shubham Shrivastava & Shikar Upadhyay [1] investigate the cylinder block made in 3D software Solidworks in which perpendicular fins are mounted. they modify the engine cylinder block fins, and its thickness reduced from 3 mm to 2 mm. so that weight reduced and also choose material which replace the existing materials, they analyzes aluminium alloy 1050 for thermal analysis to evaluate the better heat transfer rate. they reduce the weight 13.2 %, of block due to modification and 2.1 % by change material without compromising with strength.

Vinay Kumar Attar & Himanshu Arora [2] They investigate Piston skirt which appear deformation at work usually causes crack on the upper end of piston head. they found that the situation becomes more serious when the stiffness of the piston is not enough and the crack appeared which may gradually extend and even cause splitting along the piston vertically. they explained the stress distribution on the piston mainly depends on the deformation of piston in order to reduce the stress concentration.

Chidiebere Okeke-Richard & Sunny Sharma [3] They analyze cylinder blocks of 4Stroke SI Engines of two wheelers from three different companies like HONDA, TVS, YAMAHA, to find out the thermal effects of combustion gases with respect to change in temperature and heat flux From the analysis they conclude that Honda

Activa always have higher amount of heat dissipated throughout the time than TVS Wego and also state that the Yamaha Ray Z, dissipates the least in the winter season irrespective of the difference in thermal properties.

G.Bahadur Vali & Krishna Veni [4] In this project they have design an assemble cylinder and cylinder head. they used two different Aluminum alloys 6061 and 7475. performed Thermal analysis on the cylinder to determine the thermal behavior for aluminum alloys for original model and also by changing the thickness of the cylinder head. they further explained that by reducing the thickness, the weight of the component reduces. By observing the thermal analysis results heat flux is more for the modified model than for original model. after comparing the result between two alloy, heat flux is more for Aluminum alloy 6061 than aluminum alloy 7475.

Abhishek Mote et al [5] they analyze of heat transfer crosswise finned surfaces using CFD software. they thought that experiment based research done by different researchers in the past is a time consuming process, hence CFD software was used to simulate the heat transfer across fins of an IC Engine and simulated results compared with experimental results.

KM Sajesh, Neelesh Soni and Siddhartha Kostti [6] They perform CFD analysis of rectangular fins of engine. they choose two wheeler bike engine (e.g. Unicorn bike engine) and geometry is designed in Design Modeler in ANSYS 16.0. they used for is Al 6063 which was a thermal conductivity of 200 W/mK. they do modification in design of engine is made by creating holes on fin. performed transient and steady state heat transfer analysis on the engine for a period of 400 second. they study the variation of temperature on creation of various diameters like 2mm, 6mm, & 10mm holes on fin. and also perforated fin was compared with an imperforate fins to observe the differences. They observed that before a time of 400 second the transient temperature of all fins was reached to steady state temperature. and fin with a hole of 10mm diameter has decrease the minimum temperature of 1036.5 K for an imperforated fin to a temperature of 989.03K.

Mr. Manir Alam & Mrs. M. Durga Sushmitha[7] they worked on a cylinder fin body for motorcycle is modeled using modeling software CATIA. The original model is changed by geometry of the fin body and distance between the fins and thickness of the fins they used material for fin body is Cast Iron. thermal analysis is done for all the three materials Cast Iron, Copper and Aluminum alloy 6082. they observed the thermal analysis result, heat flux is more for Aluminum alloy than other two materials and also by using Aluminum alloy the body weight is less so using Aluminum alloy 6082 is better.

Swati Saini & Kagdi Dhruvin Nileshkumar [8] they performed CFD simulation for the results obtained by the experiments conducted by Thornhill et al and Yoshida et al. the heat transfer growth can be performed using the same cylinder with different fin profiles. The fin profile selected

for heat transfer augmentation is developed using CAD software and simulation was carried out in similar way as performed for experimentally.

P.T. Nitnaware & Prachi S. Giri [9] They investigate the effect of fin geometries and coefficient of heat transfer coefficient and material they study for the heat loss for air cooling for an IC engine. heat transfer per unit weight of fin is larger for conical fin than the rectangular fins. that is why conical fins are preferred over rectangular cross section fins. The rate of heat transfer increases with increasing h. for small values of h the Aluminum is the better material for designing fins for air cooled engines due to less weight, high rate of heat transfer and lower cost.

H.Sumithra & B. Sandhya Rani [10] After doing the three different coupled (thermal & structural) analysis with three different materials they found that the maximum stresses for three materials. Before Modification Material Aluminum92, Aluminum96 and Aluminum Silican Nitrate the maximum temperatures are 671.45 °C, 665.74 °C and 505.73 °C. After Modification For Material Aluminum-92, Aluminum-96 and Aluminum Silican Nitrate the maximum temperatures are 459.68 °C ,449.91 °C and 294.95 °C. Finally they concluded that the Silican Nitrate was best material among all due to factor of Safety than other two. The Model weight is reduced after modification from 1.643kg to 1.627kg at a Density of 3000Kg/m³.

M Syamala Devi, E Venkateswara Rao & K Sunil Ratna Kumar [11] From this analysis they concluded that shape and thickness along with material plays an important role to define the amount of heat transfer from the fins. they keep reducing the thickness and heat transfer rate for a defined shape and material. From the results they observed that 2 mm thickness is giving the better results compared to 3 & 2.5 mm. they also analyzed the fins heat transfer rate with 2 materials like LM13 & Al Alloy. Al alloy is giving the better results compared to the LM13 as Al alloy is having the better thermal conductivity.

Athirah Abdul Aziz, Adlansyah Abd Rahman and Abdul Aziz Hassan[12] They proposed the design of modular cylinder head for a 150 cc racing motorcycle engine which provides the flexibility to change the internal architecture and use different components in the cylinder head to get the good engine performance. They divide cylinder head into three part consisting of the cylinder head cover, the valve-train housing and the combustion chamber housing. The detailed design was then done and finalized. The computational work of stress and thermal analysis was done on ANSYS software.

Gokul Karthik[13] They analyze the thermal properties and increase the air flow efficiency of two wheeler engines by varying geometry of the fins. They create models by varying the geometry of the fins. The 3D modeling software used is Pro/Engineer. The analysis is done using ANSYS. They use material of cylinder fin body is Aluminum 106 Alloy with thermal conductivity of 202.4W/mk. They

analyze Aluminum 1060 alloy having higher thermal conductivities.

Shamim Alam & Dr. Gaurav Tiwari[14] They Investigate the efficiency of fin with 5 mm base width is greater than the fin having base with 4mm by 30.92 %. When the length is 13 mm the efficiency of fin with 5 mm base width is greater than the fin having base with 4mm by 5.07 %. When the length is 15 mm the efficiency of fin with 5 mm base width is greater than the fin having base with 4mm by 7.89 %. and When the base width is 4 mm the efficiency of fin having 15 mm length is greater by one % of fin having length 13 mm & greater by 28.24 % of fin having length 11 mm. The overall conclusion, the efficiency of fin having 5 mm base width with 15 mm length is greater among the six cases.

Ashwin Shridhar, Asokan Ram Deepak & S Jayaraj[15] They compared helical airfoil fin model with a standard rectangular cross section circular finned model by performing Heat transfer analysis on both models in the same environment. From the CFD analysis They obtained the Velocity distribution, Temperature distribution and heat transfer coefficient distribution for both the models They conclude that the helical airfoil model is more efficient than the circular fin.

3. Objective:

There are following objective are to be expected from the present work

1. The primary object of the present work to increase heat transfer rate from existing engine design.
2. To study the behavior of heat transfer from internal combustion engine.
3. To evaluate the heat transfer rate by using transient thermal analysis for Actual IC engine cylinder.
4. To evaluate the heat transfer rate with proposed design by using transient thermal analysis for IC engine cylinder.
5. To present optimized design of the IC engine from the basis of heat transfer rate.
6. To interpret the result of existing and proposed design of IC engine cylinder.

4. Methodology:

4.1 Mathematical Analysis:

The purpose of fins in IC engine is to enhance convective heat transfer from engine. The primary purpose behind the operation of fins is to raise the effective heat transfer area from the surface. A balance of energy is performed on this element in which it is assumed that the element is at constant and uniform temperature of T.

$$\text{Heat in to the left face} = \text{Heat out from the right face} + \text{Heat loss by convection}$$

This yield

$$Q_x = Q_{x+\Delta x} + Q_{con}$$

after solving the above equation we got the general solution

$$\theta = C_1 e^{-mx} + C_2 e^{mx}$$

Where C_1 and C_2 are constant that can be determined from the boundary conditions.

Case I: The fin is very long and the temperature at the end of the fin is approach to the temperature of the surrounding T_∞ .

Conductive heat transfer at the base of fin, according to Fourier's law

$$Q_{Fin} = -kA \left(\frac{dT}{dx} \right)_{x=0}$$

$$Q_{Fin} = \sqrt{hPkA}(T_0 - T_\infty)$$

Case II: Fin Insulated at the tip

$$Q_{Fin} = \sqrt{hPkA}(T_0 - T_\infty) \tanh(ml)$$

Where

$$m = \sqrt{\frac{hP}{kA}}$$

Case III: fin with heat losing at the tip/Heat losing from finite length of the fin

$$Q_{Fin} = \sqrt{hPkA}(T_0 - T_\infty) \left[\frac{\tanh(ml) + \frac{h}{km}}{1 + \frac{h}{km} \tanh(ml)} \right]$$

In the present work the heat is transfer from the engine to the surrounding follow case III.

4.2 Finite Element Analysis: it is a method for evaluating how a product reacts in real world during forces, heat & fluid flow, vibration and other physical effects. It also helps to confirm whether a product will fail or work the way it was designed. In the present work Transient thermal analysis is performed for single cylinder four stroke spark ignition engine of Bajaj Discover 125 Bike with the help of workbench of ANSYS 16.0.

4.2.1 Transient Thermal analysis for actual design of engine: Thermal analysis is a technique in which a property of the work is monitored against the time and in a definite atmospheric conditions. The thermal analysis allow to learn that how chemical processes which are associated with heating or cooling.

Transient thermal analysis is used to determine temperature distribution and other thermal parameters that may vary over the time. The procedure of transient thermal analysis is very much similar as steady state thermal analysis. The main difference is that for the most part applied loads for the transient thermal analysis are a function of time.

4.2.1.1 CAD geometry: In the present work The CAD geometry of engine is created with the help of CATIA software with actual dimension, then imported in ANSYS workbench for further Transient thermal analysis. A CAD Geometry in three dimensional view of engine cylinder is shown in figure No. 4.

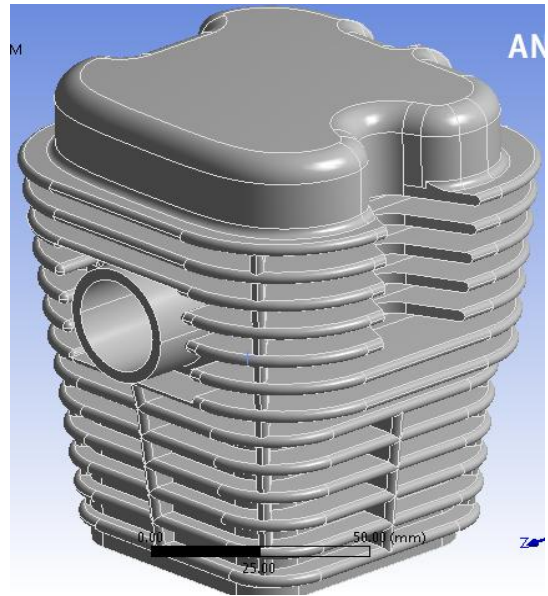

Figure 4: CAD Model of Actual Engine Cylinder

4.2.1.2 Meshing: Meshing is a critical operation in FEM in this process the CAD geometry is divided into numbers of small pieces. The small pieces are called mesh. The analysis accuracy and calculation duration depends on the mesh size and orientations. The mesh created in this work is shown in figure No.5 The total Node is generated 844969 & Total No. of Elements is 494644. Types of element used in the present work is solid87. It is clear from the present mesh geometry the total node numbers and total element numbers are six in digit which show that the mesh is very fine because the result accuracy depends on the mesh quality.

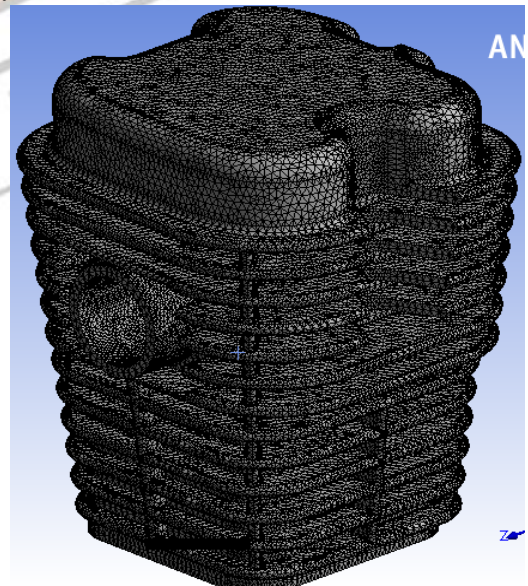

Figure 5: Meshing of Actual Engine Cylinder

4.2.1.3 Defining Material Properties: for any kind of analysis material property are the main things which must be defined before moving further analysis. In the present work Aluminium alloy is used as a material of engine cylinder. The material properties of the present case are as: Density: 2700 kg/m³, Isotropic thermal conductivity: 167 w/m°C, Specific Heat: 896 J/kg °C.

4.2.1.4 Boundary condition:

1. The maximum temperature generated inside the cylinder block is taken as 650 °C
2. For the meshing SOLID87 element is used.
3. The increment of temperature magnitude factor is applied 200+3.75*y.
4. The value of convective coefficient for the present work is taken as 100 W/m².
5. The value of Isotropic thermal conductivity of the material at ambient temperature 22 °C is taken as 148.62 w/m °C.
6. The Mechanical APDL solver is used for transient thermal analysis.

4.2.1.5 Temperature Distribution of Actual Engine Cylinder:

Transient thermal analysis where performed on actual engine cylinder at 25 °C at atmospheric temperature and result indicates the temperature distribution of actual engine cylinder the maximum temperature is 650 °C and minimum temperature is 92.091 °C. Figure No. 6 showing temperature distribution over the actual engine cylinder with different color contours.

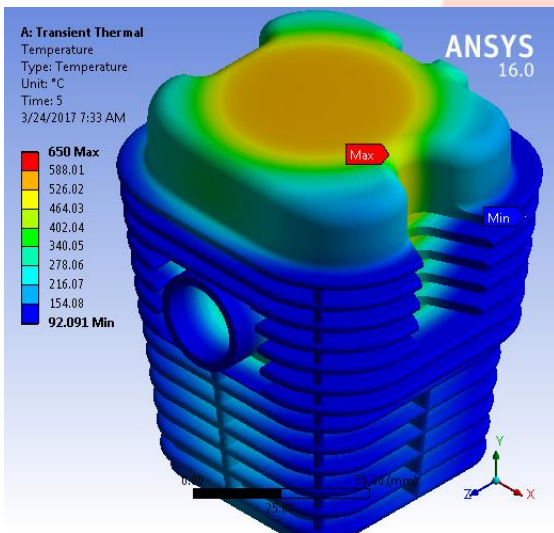

Figure 6: Temperature distribution on actual engine cylinder

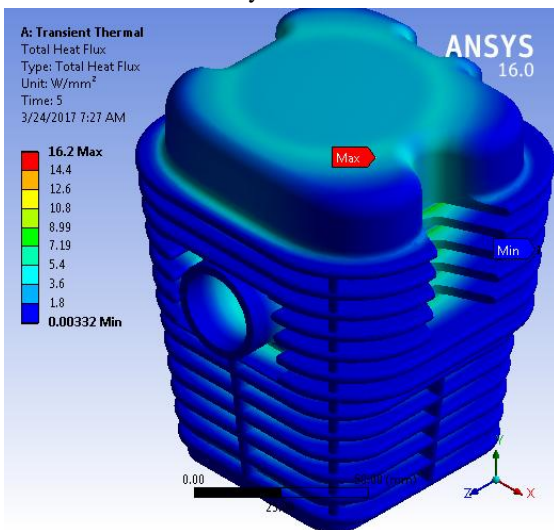

Figure 7 : Total Heat Flux for actual engine cylinder

4.2.1.6 Total heat flux: The total heat flux generated on the actual engine cylinder Maximum Value of total heat flux generated is 16.2 W/mm² and minimum heat flux generated is 00332 W/mm² as shown in Figure No 7

4.2.1.7 Directional heat flux in Y-direction: The directional heat flux in the Y- direction generated on the actual engine cylinder, Maximum value of Directional heat flux generated is 10.118 W/mm² and minimum Directional heat flux generated is -5.8731 W/mm² as shown in Figure No.8.

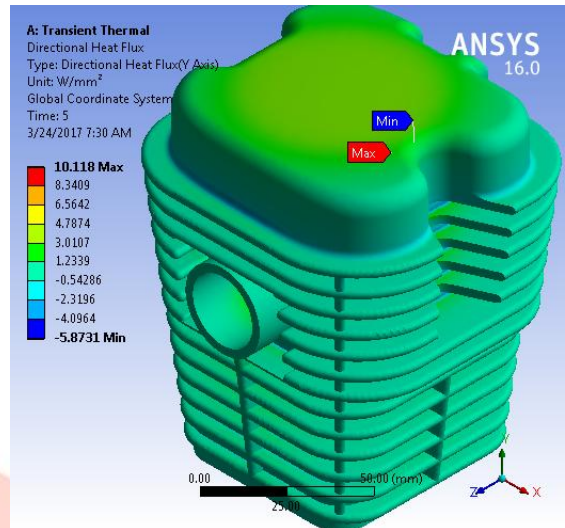

Figure 8: Directional Heat Flux for actual engine cylinder in Y- direction

4.2.2 Transient Thermal analysis of proposed Design-1 of engine :

4.2.2.1 CAD geometry: The CAD geometry of proposed design-1 of engine cylinder is created with the help of CATIA software then imported in ANSYS workbench for further analysis. A three dimensional view of engine cylinder is shown in figure No 9.

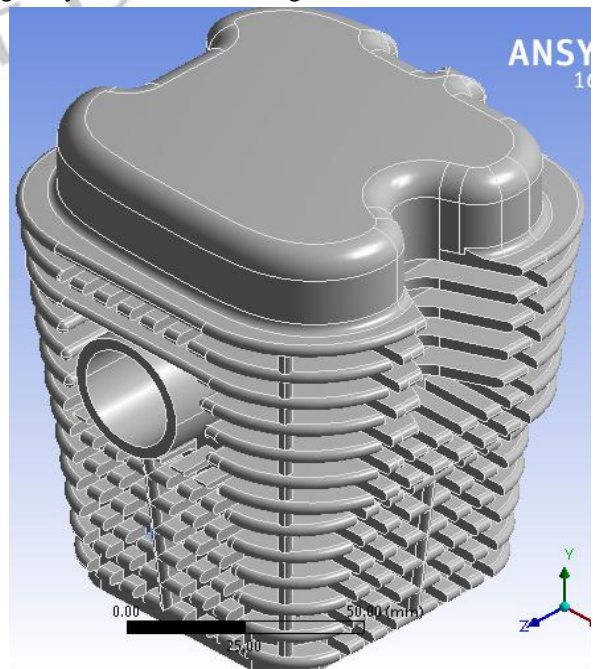

Figure 9: CAD Geometry of proposed design-1

4.2.2.2 Meshing: The mesh created in this work is shown in figure No 10. Total node is generated 949680 & Total No. of Elements is 550940. Types of element used in the present work is solid87.

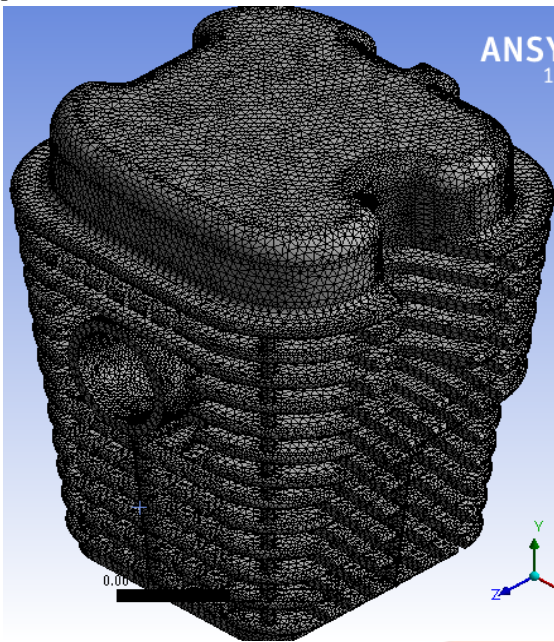

Figure 10: Meshing for proposed design -1 of Engine Cylinder

Note: Material property and boundary conditions remain similar as actual design that is why no need to explain in this section again.

4.2.2.3 Temperature Distribution For Proposed Design-1:

Transient thermal analysis where performed for proposed design-1 of engine cylinder at the same atmospheric temperature as actual engine cylinder and the result indicates the temperature distribution for proposed design-1 of actual engine cylinder the maximum temperature is 650 °C and minimum temperature is 90.078 °C. Figure No.11.

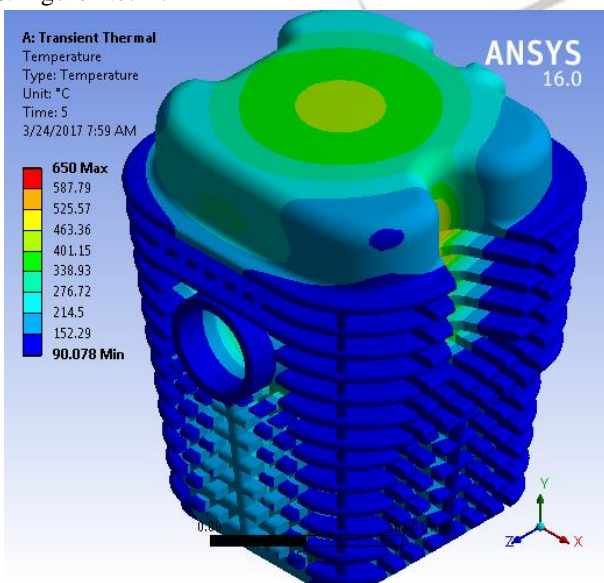

Figure 11 : Temperature distribution on Proposed design-1 of engine cylinder

4.2.2.4 Total Heat Flux for proposed design-1: Total Heat Flux for proposed design-1 maximum value of total heat flux is 18.825 W/mm² and minimum total heat flux is 0.00223 W/mm². as shown Figure No. 12.

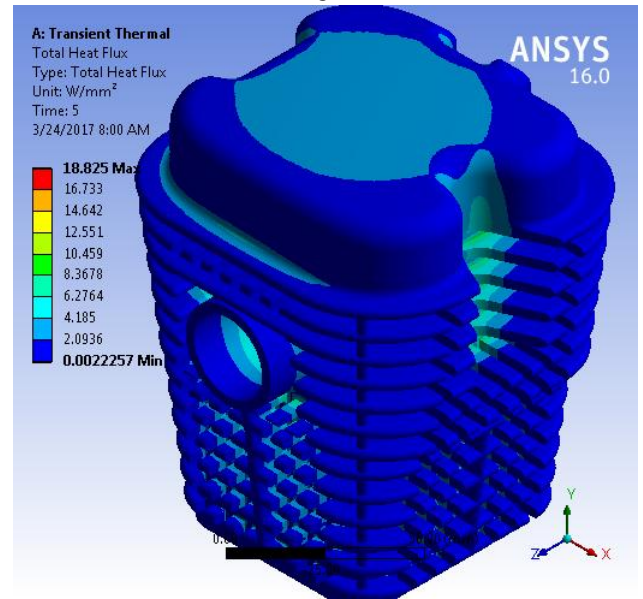

Figure 12: Total Heat Flux for Proposed design-1 of engine cylinder

4.2.2.5 Directional Heat Flux in the Y- direction for proposed design-1: The directional heat flux in the Y- direction generated for proposed design-1 and the maximum value of directional heat flux is 12.539 W/mm² and minimum directional heat flux is -6.431 W/mm². as shown in Figure No. 13.

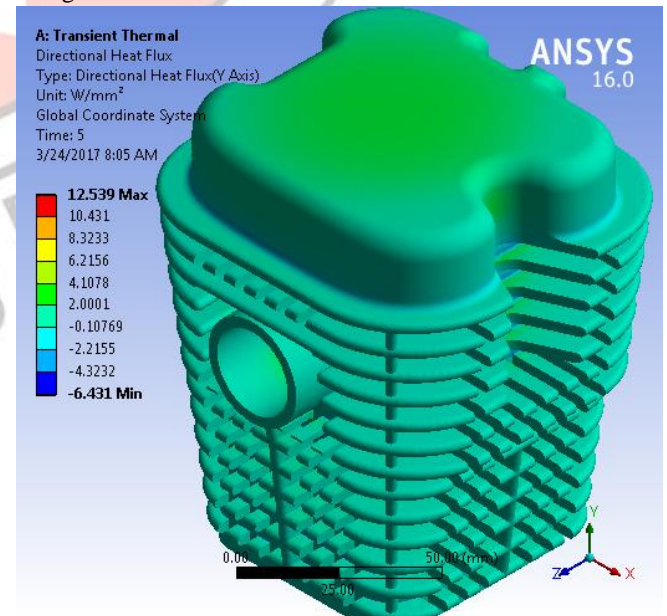

Figure 13: Directional Heat Flux for Proposed design-1 of engine cylinder in Y- direction

4.2.3 Transient Thermal analysis of proposed Design-2:

4.2.3.1 CAD geometry: The CAD geometry of proposed design-2 of engine cylinder is created with the help of CATIA software then imported in ANSYS workbench for further analysis. A three dimensional view of engine cylinder is shown in figure No. 14.

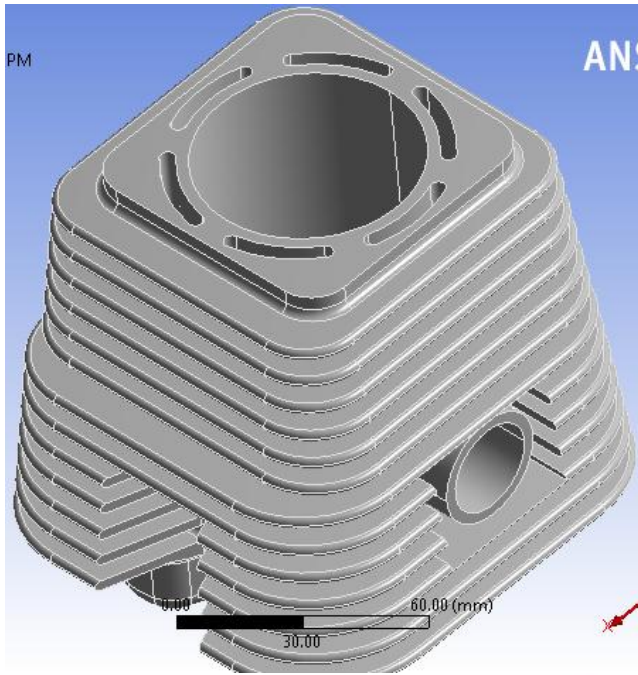

Figure 14: CAD geometry of proposed design-2

4.2.3.2 Meshing: The mesh created for design-2 is shown in figure No 15. The total Node is generated 1333808 & Total No. of Elements is 776470. Types of element used in this work is solid87. It is clear from the present mesh geometry the total node numbers and total element numbers are six in digit which show that the mesh is very fine because the result accuracy depends on the mesh quality.

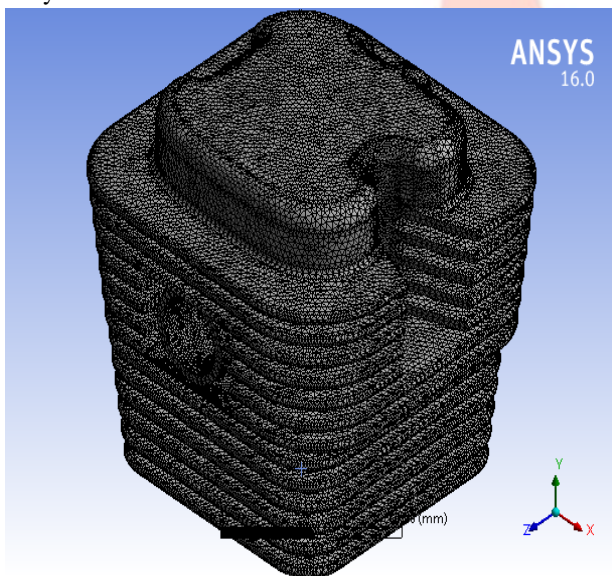

Figure 15: Meshing for proposed design -2 of Engine Cylinder

4.2.3.3 Temperature Distribution For Proposed Design-2: Transient thermal analysis where performed for proposed design-2 of engine cylinder at the same atmospheric temperature as actual engine cylinder and the result indicates the temperature distribution for proposed design-2 the maximum temperature is 650 °C and minimum temperature is 74.739 °C as shown in figure No. 16

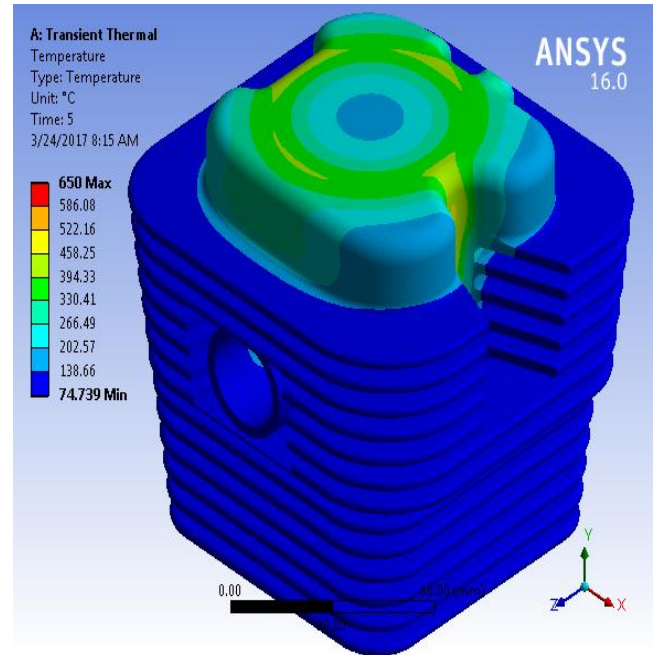

Figure 16: Temperature distribution on Proposed design-2 of engine cylinder

4.2.3.4 Total Heat Flux for proposed design-2: Transient thermal analysis where performed for proposed design-2 of engine cylinder at the same atmospheric temperature as actual engine cylinder and the result indicates the Total Heat Flux for proposed design-1 the maximum value of total heat flux is 29.665 W/mm² and minimum total heat flux is 0.00353 W/mm² as shown in figure No. 17

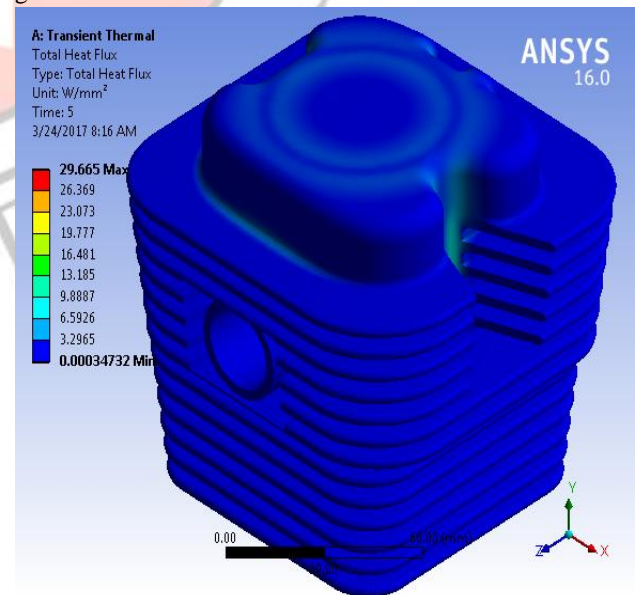

Figure 17: Total Heat Flux for Proposed design-2 of engine cylinder

4.2.3.5 Directional Heat Flux in the Y- direction for proposed design-2: The directional heat flux in the Y- direction generated for proposed design-2, the maximum Directional Heat Flux is 23.894 W/mm² and minimum Directional Heat Flux is -21.413 W/mm² as shown in figure No. 18

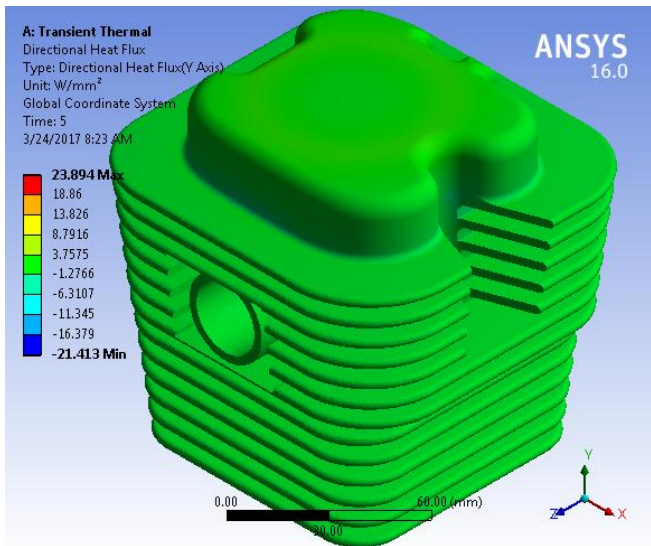

Figure 18: Directional Heat Flux for Proposed design-2 of engine cylinder in Y- direction

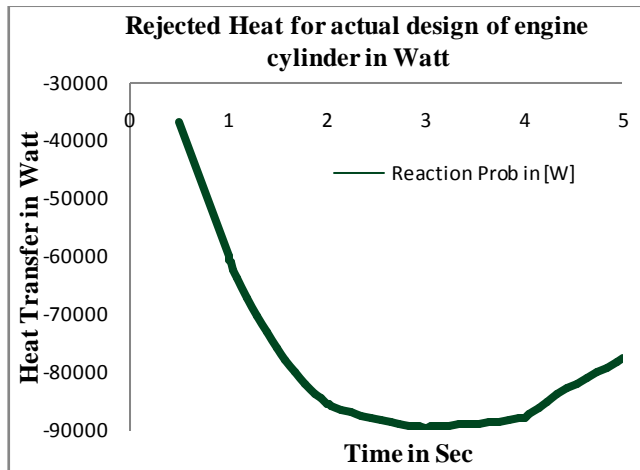

Figure 20: Heat Rejected for actual design of engine cylinder

5. Result and discussion:

The transient thermal analysis were performed using an analytical software ANSYS workbench based on finite volume analysis. The effects of different important geometrical parameters for the transient natural convective heat transfer rate from both actual and proposed design of engine.

5.1 Assumptions for Transient Thermal Analysis:

The following assumptions are made to perform thermal analysis of Bajaj discover 125 engine.

- Symmetric flow and identical heat transfer throughout the engine body.
- Isothermal boundary condition is applied for the fins attached with engine.
- Air entrance from the side is Negligible on the heat sink means the fresh air inflow and outflow from the open sides of the outmost fins wall is small compared to the air flow entering from the bottom of the fins array.

5.2 Results for Actual design of engine cylinder:

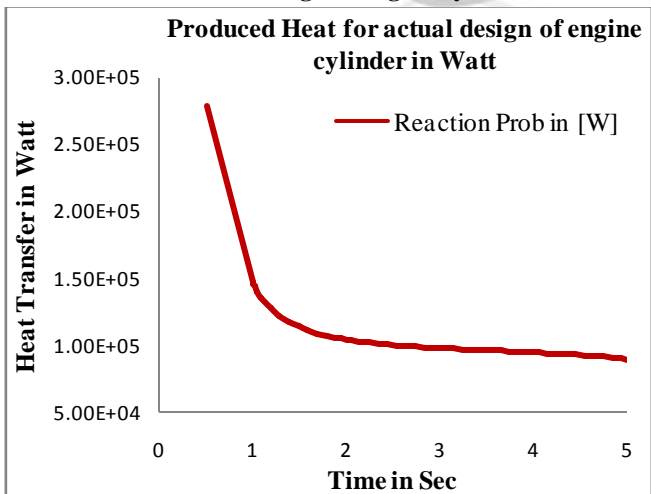

Figure 19: Heat Produced for actual design

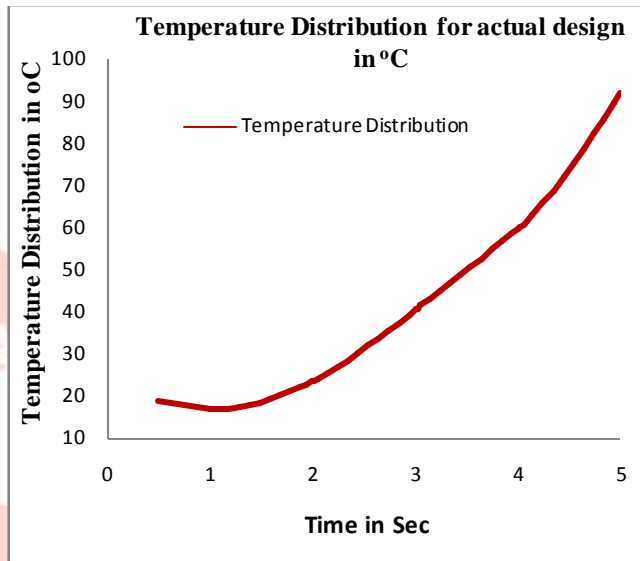

Figure 21: Temperature Distribution for actual design

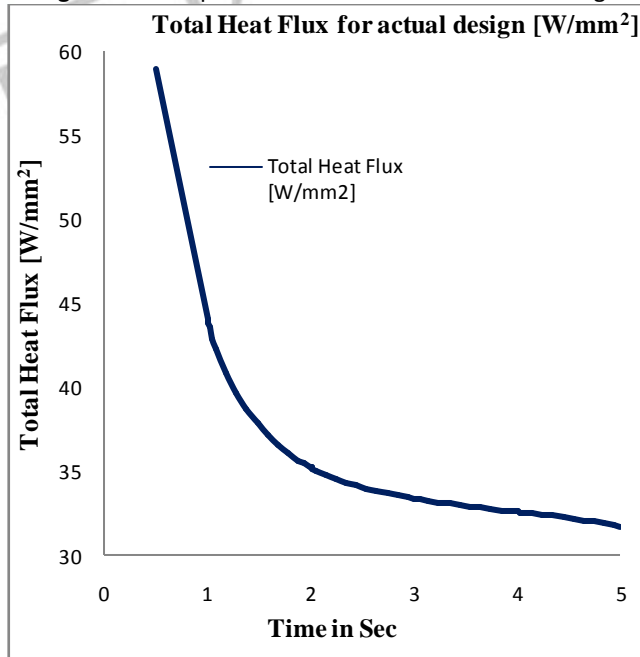

Figure 22: Total Heat Flux for actual design

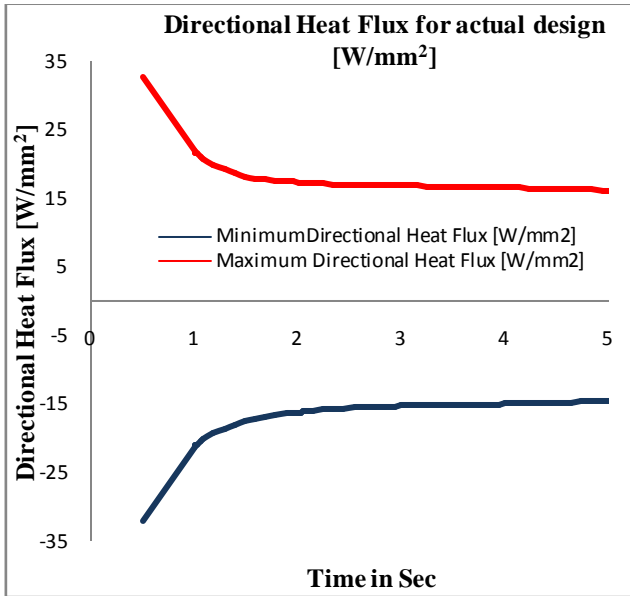

Figure 23: Directional Heat Flux for actual design

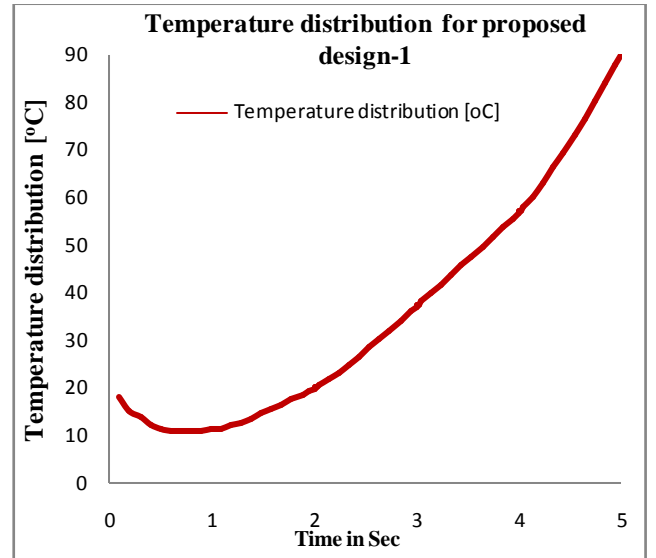

Figure 26: Temperature Distribution for Proposed design-1

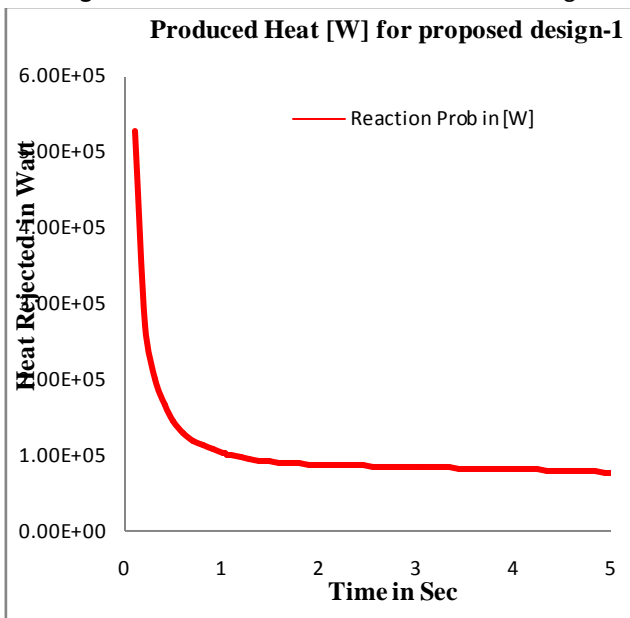

Figure 24: Heat Produced for Proposed design-1

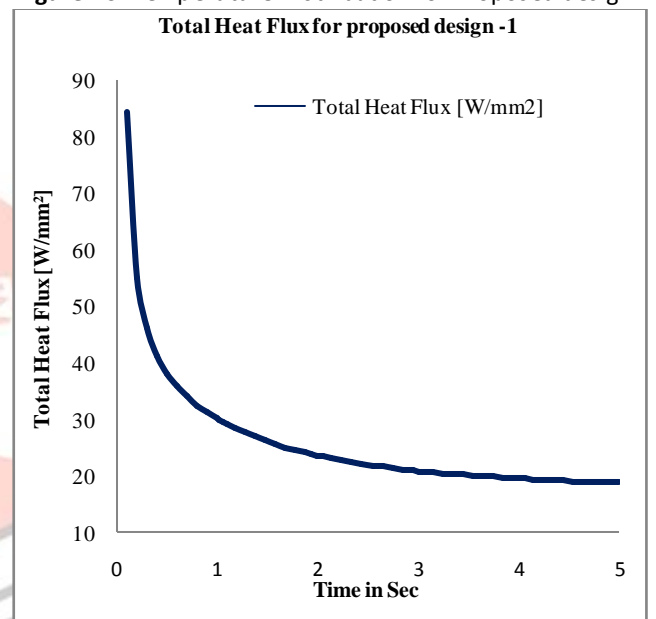

Figure 27: Total Heat Flux for Proposed design-1

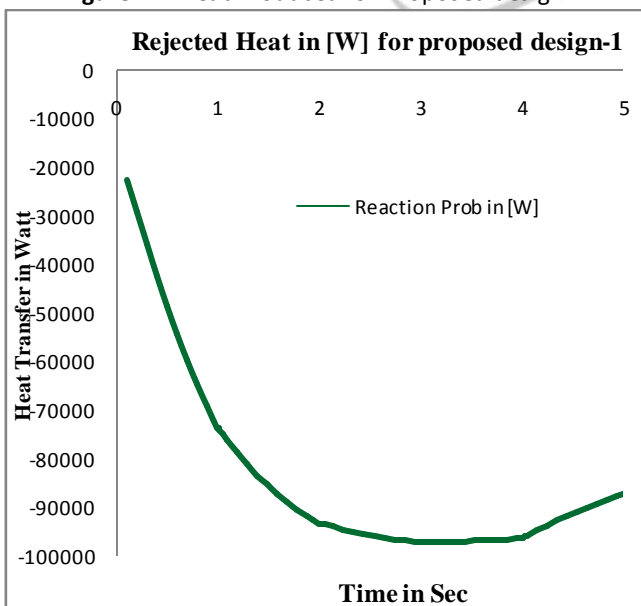

Figure 25: Heat Rejected for Proposed design-1

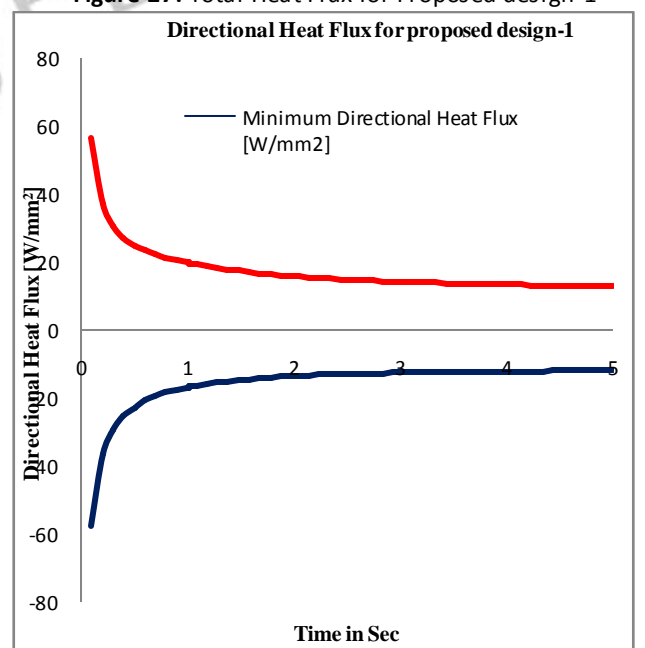

Figure 28: Directional Heat Flux for Proposed design-1

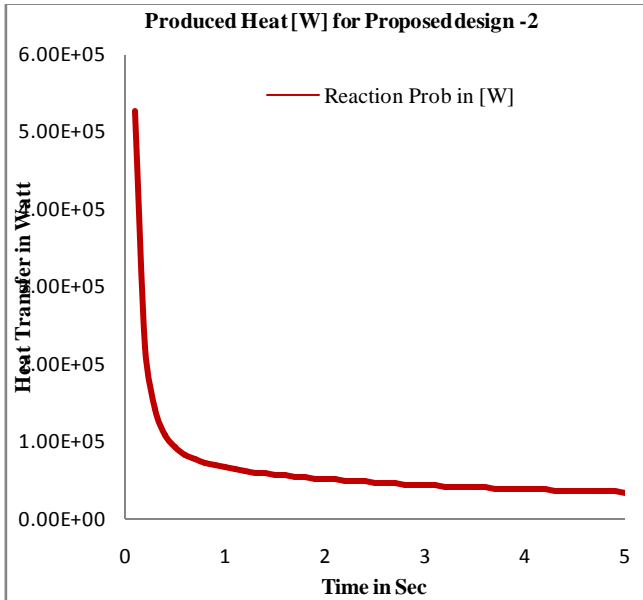

Figure 29: Heat Produced for Proposed design-2

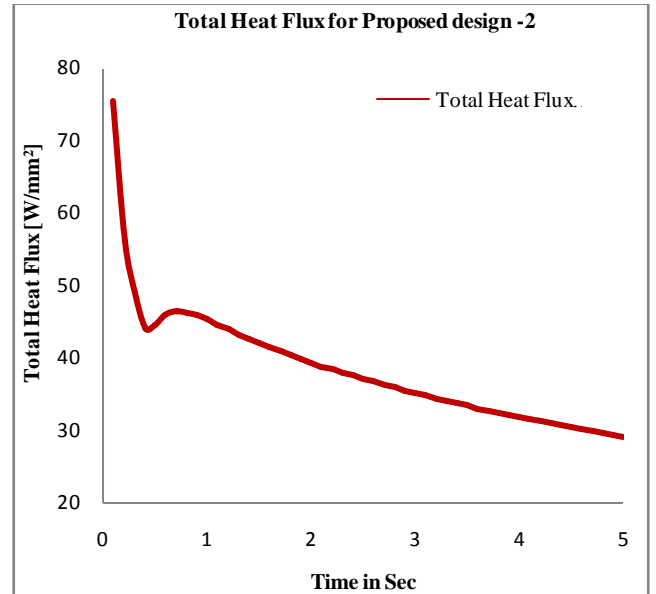

Figure 32: Total Heat Flux for Proposed design-2

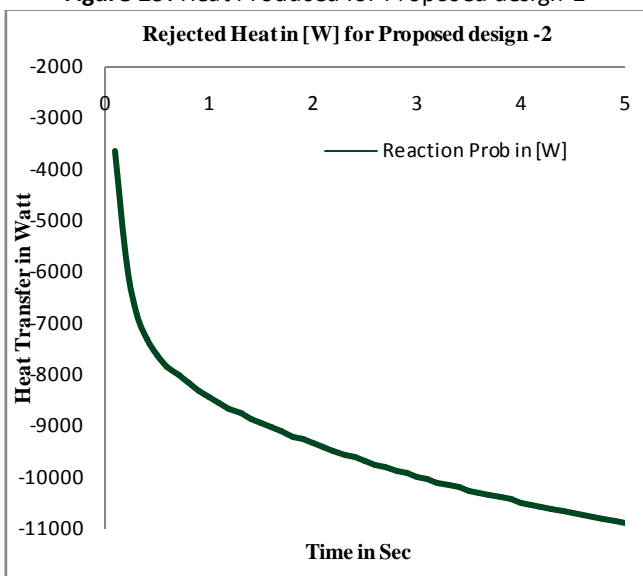

Figure 30: Heat Rejected for proposed design-2

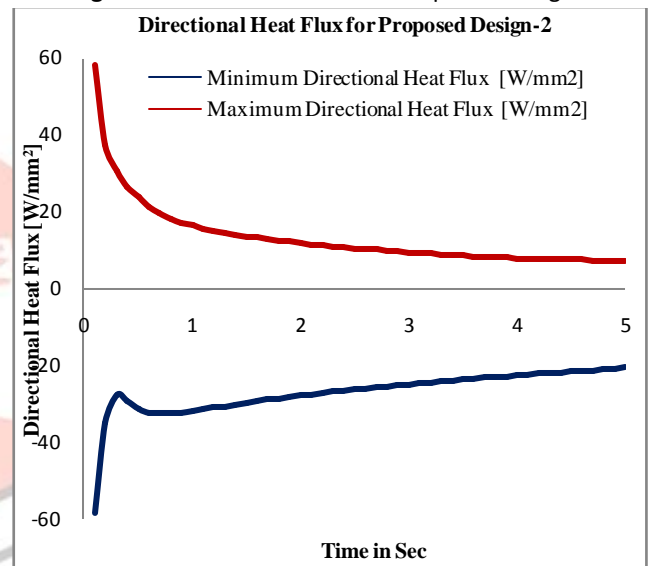

Figure 33: Directional Heat Flux for Proposed design-2

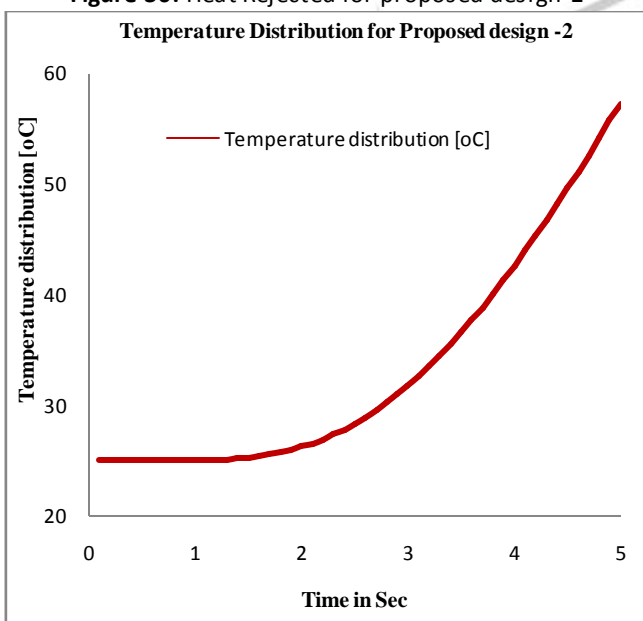

Figure 31: Temperature Distribution for Proposed design-2

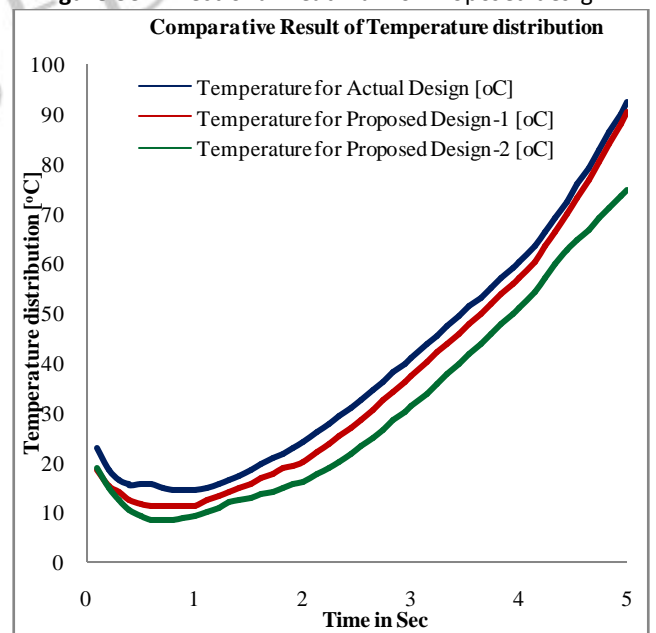

Figure 34: Comparative Result of Temperature distribution

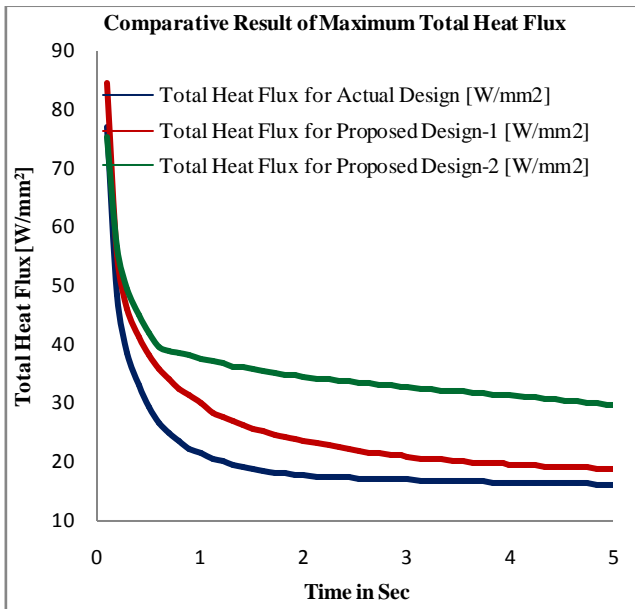

Figure 35: Comparative Result of Maximum Total Heat Flux

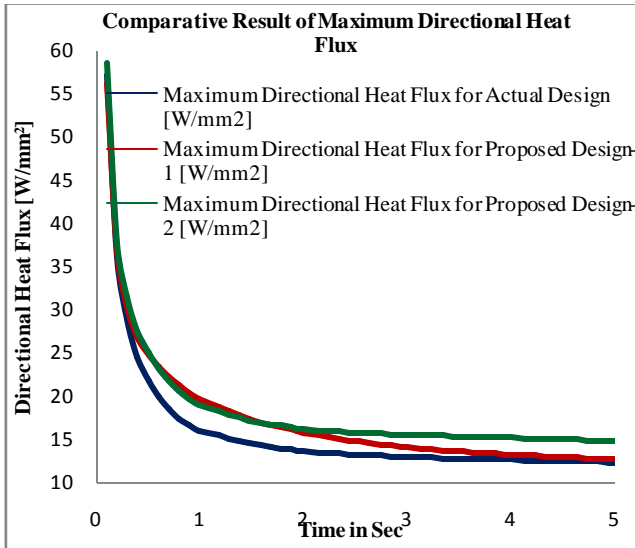

Figure 36: Comparative Result of Maximum Directional Heat Flux

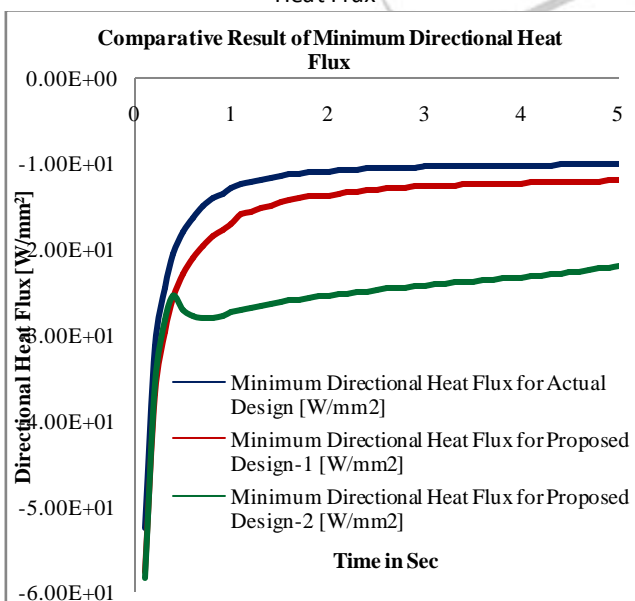

Figure 37: Comparative Result of Minimum Directional Heat Flux

6. Conclusion:

Transient thermal analyses were performed for actual and proposed design of engine cylinder in order to optimize geometrical parameters and enhanced heat transfer from the IC engine. In the present work transient thermal analysis is performed on actual design and also on two different geometrical designs at ambient temperature 25 °C.

The following points have been recognized in the form of conclusive statements which are as follows.

1. The result of transient thermal analysis of actual design of engine cylinder at ambient temperature 25 °C indicates the maximum temperature is 650 °C and minimum temperature is 92.091 °C, Maximum Total heat flux generated is 16.2 W/mm² and minimum heat flux generated is 0.0332 W/mm², The maximum directional heat flux in X-direction generated is 12.35 W/mm² and minimum Directional heat flux generated is -10.108 W/mm², Maximum Directional heat flux in Y-direction generated is 10.118 W/mm² and minimum Directional heat flux generated is -5.8731 W/mm² and Maximum Directional heat flux in Z-direction generated is 13.977 W/mm² and minimum Directional heat flux generated is -13.767 W/mm².
2. The result of transient thermal analysis of proposed design-1 of engine cylinder at ambient temperature 25 °C indicates the maximum temperature is 650 °C and minimum temperature is 90.078 °C, Maximum Total heat flux generated is 18.825 W/mm² and minimum heat flux generated is 0.00223 W/mm², The maximum directional heat flux in X-direction generated is 12.714 W/mm² and minimum Directional heat flux generated is -12.024 W/mm², Maximum Directional heat flux in Y-direction generated is 12.539 W/mm² and minimum Directional heat flux generated is -6.431 W/mm² and Maximum Directional heat flux in Z-direction generated is 14.907 W/mm² and minimum Directional heat flux generated is -14.778 W/mm².
3. The result of transient thermal analysis of proposed design-2 of engine cylinder at ambient temperature 25 °C indicates the maximum temperature is 650 °C and minimum temperature is 74.739 °C, Maximum Total heat flux generated is 29.665 W/mm² and minimum heat flux generated is 0.00353 W/mm², The maximum directional heat flux in X-direction generated is 14.803 W/mm² and minimum Directional heat flux generated is -22.072 W/mm², Maximum Directional heat flux in Y-direction generated is 23.894 W/mm² and minimum Directional heat flux generated is -21.413 W/mm² and Maximum Directional heat flux in Z-direction generated is 14.346 W/mm² and minimum Directional heat flux generated is -14.15 W/mm².

To summarize this conclusion, the proposed design -2 of IC engine has better performance and heat transfer rate from the heating zone in the IC engine that is why the result of

present work is more concentrate on it and also proposed replacement of new design.

6.1 Future Work:

The aim of present work to increase heat transfer rate from the heating zone in IC engine, for that transient thermal analysis have been performed on actual design of bajaj discover 125 CC single cylinder engine. There are some possible future works which may be possible for further analysis;

1. Radiation analysis can also be performed for the same work.
2. In all types of analysis in the present work the material used for cylinder block is aluminium alloy; some other material may also used.
3. CFD analysis can also be done to understand air flow around the cylinder block.
4. Evaluation of thermal properties by varying the size and thickness of the heat sink also.

7. References:

- [1] Shubham Shrivastava & Shikar Upadhyay "Thermal Analysis of IC Engine Cylinder Block with Fins Perpendicular to the Axis of Piston Movement" International Journal of Mechanical and Industrial Technology ISSN 2348-7593 (Online) Vol. 3, Issue 2, pp: (139-149), Month: October 2015 - March 2016.
- [2] Vinay Kumar Attar & Himanshu Arora "Transient Thermal Analysis of Internal Combustion Engine Piston in Ansys Workbench By Finite Element Method" International Journal of Engineering Sciences & Research Technology, ISSN: 2277-9655 Attar* et al., 5(6): June, 2016.
- [3] Chidiebere Okeke-Richard & Sunny Sharma "Thermal Analysis and Comparison of Cylinder Blocks of 4S, SITwo Wheeler Engine Using ANSYS" International Journal of Innovative Science, Engineering & Technology, ISSN 2348 – 7968 Vol. 3 Issue 5, May 2016.
- [4] G.Bahadur Vali & Krishna Veni "Design/Modeling and Thermal Analysis on Cylinder Head of I.C Engine" International Journal & Magazine of Engineering, Technology, Management and Research, ISSN No. 2348-4845 Volume No.03 (2016), Issue No.05 (may).
- [5] Abhishek Mote at el "Analysis of Heat transfer through fins of an IC Engine using CFD" International Research Journal of Engineering and Technology (IRJET) e-ISSN: 2395 -0056, p-ISSN: 2395-0072, Volume: 03 Issue: 04 | Apr-2016.
- [6] KM Sajesh, Neelesh Soni and Siddhartha Kosti "Design Modification and Heat Transfer Analysis of Air Cooled Rectangular Fin Engine" International Journal of Recent Scientific Research ISSN: 0976-3031 Volume: 7(3) March -2016.
- [7] Mr. Manir Alam & Mrs. M. Durga Sushmitha "Design and Analysis of Engine Cylinder Fins of Varying Geometry and Materials" International Journal of Computer Engineering In Research Trends, ISSN (O): 2349-7084 Volume 3, Issue 2, February-2016, pp. 76-80.
- [8] Swati Saini & Kagdi Dhruvin Nileshekumar "Comparison of CFD Analysis of Heat Transfer Augmentation & Surface Heat Transfer Co efficient of I. C. Engine Fins at Different wind Velocities with Experimental Investigation" International Journal for Scientific Research & Development| Vol. 4, Issue 03, 2016 |ISSN (online): 2321-0613.
- [9] P.T. Nitnaware & Prachi S. Giri "Design Optimization Of An Air Cooled Internal Combustion Engine Fin Using CFD" Journal of Multidisciplinary Engineering Science and Technology (JMEST) ISSN: 3159-0040 Vol. 2 Issue 11, November - 2015.
- [10] H.Sumithra & B. Sandhya Rani "Design Optimization and Transient Thermal Analysis of Four Stroke Petrol Engine Cylinder Head" International Journal of Emerging Technology in Computer Science & Electronics (IJETCSE) ISSN: 0976-1353 Volume 18 Issue 2 – NOVEMBER 2015.
- [11] M Syamala Devi, E Venkateswara Rao & K Sunil Ratna Kumar "Optimization of Engine Cylinder Fin by Varying its Geometry and Material" International Journal of Science and Research (IJSR) ISSN (Online): 2319-7064, Paper ID: SUB159073 , Volume 4 Issue 10, October 2015.
- [12] Athirah Abdul Aziz, Adlansyah Abd Rahman and Abdul Aziz Hassan "Design of Customized Modular Cylinder Head for Si-Engine" ARPN Journal of Engineering and Applied Sciences ISSN 1819-6608, VOL. 10, NO. 17, SEPTEMBER 2015.
- [13] Gokul Karthik "Design Modification and Analysis of Fins in Two Wheeler Engines by CFD" International Journal of Research in Electrical and Electronics Technology (IJREET) Volume 2 - Issue 1 August 2015.
- [14] Shamim Alam & Dr. Gaurav Tiwari "Increase the Efficiency of Internal Combustion Engine Fin by Replacing the Conventional Fin with Parabolic Fin" International Journal of Analytical, Experimental and Finite Element Analysis (IJAEFEA), Issue. 2, Vol. 2, June 2015. e-ISSN: 2394-5141, p-ISSN: 2394-5133, pp 80-84.
- [15] Ashwin Shridhar at "Conjugate Heat transfer Analysis of helical fin with airfoil cross-section and its comparison with existing circular fin design for air cooled engines employing constant rectangular cross-section" Journal of Engineering Research and Applications, ISSN : 2248-9622, Vol. 5, Issue 6, (Part - 5) June 2015, pp.88-93.