

# Optimization of Grit Changing Time Duration In Coated Disc Manufacturing Plant By Using PLC Automation

Avishek Jana, Dr. Marpu Indira Rani  
 Mechatronics(Mtech)  
 Mechanical Departmenet  
 Jawaharlal Nehru Technological University Hyderabad,India

**Abstract---**Barely any methodologies in existing system has been introduced on the idea of the enhance procedure and assembling methodology and furthermore change of mechanized framework in the meantime to lessen the work and working time and to build the efficiency with various thoughts. The different methodologies has done to expand the efficiency of coated disc manufacturing ventures controlled via mechanized operations. Presently a days utilizing the programmed control supplies additionally can't fulfil the prerequisites of coated disc generation industry. The primary controlled types for coated disc (rough items) generation process take after the beneath parts:

1. High speed producer machine
2. Online curing oven
3. Sizer machine

Propose investigate resembles that each season of coarseness change administrator set aside greater opportunity to tidy up every one of those grains. To keep up every one of those things, it takes transport backward mode up to 10 sec through PLC programming. Through this execution 20 mins can be spared in coarseness changing term and furthermore profitability will increment. In this proposed work, keeping in mind the end goal to fulfill the coarseness changing time diminish and in addition amount and nature of rough items, alteration of fast creator machine with programmed control framework in view of Allen Bradely PLC 1756 is presented in subtle elements. The system of this proposal is composed as takes after. Above all else , the advancement history of rough creation mechanization is presented. At that point the innovative procedure has examined quickly. After that the advancement procedure and its usage of control framework through PLC for covered rough circle creation process are portrayed in subtle elements. At last stage, the checking framework in view of PLC and SCADA programming is portrayed.

**Objective:** The objective of this work is to optimize the grit changing time for efficiency of production uptime at the same time to reduce labor and working time and as well as increase the productivity. Idea behind this work is to control the quantity and quality of abrasive products caused by high level automation, latest technology and equipments. And the same time the rapid growth of the abrasive market capacity. In order to satisfy the grit changing time reduce as well as quantity and quality of abrasive products, modification of high speed maker machine with automatic control system based on Allen Bradely PLC 1756 is introduced in details

**Keywords---** Grit changing, plc automation, production rate, soft wiring, coated disc, allen bradely plc 1756, time duration

## I. INTRODUCTION

In the past 20 years technology has changed the nature of manufacturing. In the old days, manufacturing and fabrication were all done by hand by people. Now technology has penetrated the industry and automation has become the competitive advantage of today's manufacturing world. Automation has allowed for companies to mass produce products at outstanding speeds with great repeatability and quality. Automation is become a determining factor in whether or not accompany will remain competitive within the manufacturing industry. Although automation has set the standards for the industry and has many advantages.

The control of all plants has been carried out through computers. PLCs have made it possible to accurately control big coated abrasive manufacturing and handling factories with lower installation expenses, wiring than required with standard relays, contractor, pneumatic valves, timer and so on. The programmability features causes rapid and comfortable changes in PLC software for automation to meet the changing needs of the coated abrasive disc manufacturing plant without the need for expensive and time consuming rewiring.

This project deals with the production uptime as well as production of abrasive coated discs. The high speed maker, oven and sizer section using plc 1756 series and supervisory control and data acquisition(SCADA) HMI. By studying all the cases modifying PLC automation we get an accuracy of 99% when we compare with other control system or production modification.

By using PLC and SCADA in industries we will increase the production, Quality and quantity, energy saving,less maintenance accuracy is good When compare to other automation like relay logic control and microprocessor. In large process plants PLCs are being increasingly used for automatic startup shutdown of critical equipments. A PLC ensures that equipment cannot be started unless all the permissive condition for safe start has been established.

The basic PLC module must be sufficiently flexible and configurable to meet the diverse needs of different factories and applications. Input stimuli( either analog or digital) are received from machines, sensors or process events in the form of voltage or current. The PLC must accurately interpret and convert the stimulus for the CPU which, in turns of defines a set of instructions to the output system that control actuator on the factory floor or in another industrial environment.

A SCADA (supervisory control and data acquisition) is an automation control system that used in industries such as energy, oil, gas water, power and so on. The system has a centralized monitoring and control system of entire sites from an industrial plants. A SCADA system works by operating with signals that communicate via channels to provide the user with remote controls of any equipment in a given system.

By using PLC and SCADA , we handle whole plant easily from remote station to monitor control rooms. Mainly we studied in this implementation on plc over manual control are very easy fast and easy to change logic i.e. flexible, reliable due to absence of moving parts. Low power consumption, easy maintenance due to modular assembly, analog signal handling and close loop control programming.

**II. METHODOLOGY**

[1]Line description-- The complete line is divided into three sections, according to the functions they perform as bellows

- A. High speed maker
- B. Curing oven
- C. Sizer section

[2]Brief introduction of operations-- A fully automated coated abrasive disc manufacturing machine which also known as high speed maker machine consists of 5 sections

- A. Shear mixture
- B. loading
- C. Maker section
- D. Coating area
- E. Unloading

[3]Process description-- In geneva indexing unit for loading raw fibre disc. That unit having four rod holder to keep disc of different dia sizes.

The loading arm will take one disc through its vacuum cup and put it to resin spin table for formulation coating.

resin arm will come every time to keep require resin formulation from shear mixture container.

Then 3-ARM come and take disc for gravity coating

From gravity hooper grain used to fall and complete the primary grain coating. The extra grain will fall on gravity conveyer to reuse that same grains.

After that, electrostatic suction drum will take those disc for secondary coating. Grains will go through one conveyer i.e esu conveyor, and by step up grains will stick on the disc

Extra grains also taken by esu skip hoist for reusing.

After that, it passes through on line curing.

[4] Logical sequence--

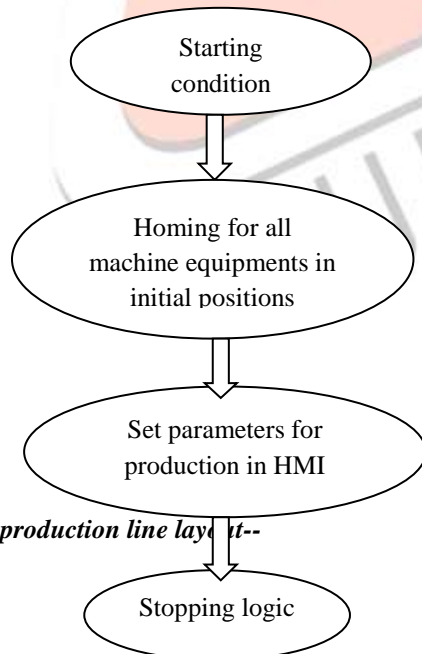

[5] Line components: disc production line layout--

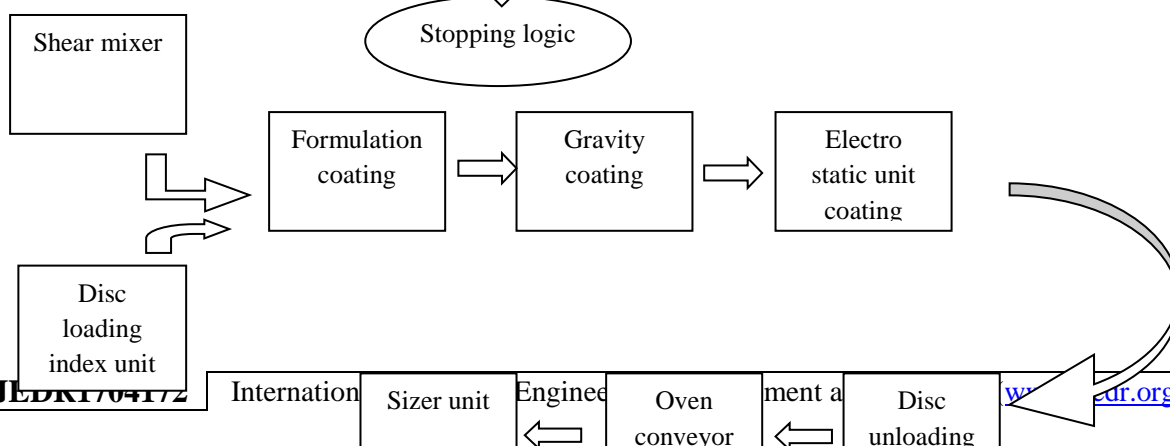

**Mixer section--** Dura powder, colour, gum, formalin and water are added in appropriate proportion and mixed in the form of formulation . formulation mixing is done with well designed stirrer revolving at required speed. Mixing starts at the press of the button in HMI and automatically shuts off at the preset time.

**Disc loading indexing unit--** At the finishing time of mixing the disc are reloaded in rod holder and one suction cup comes and load the disc one by one in the spin table

**Maker unit--** Automatically formulation from mixer poured upon disc in the spin table one by one and it goes through gravity coating .

**Gravity coating--** After pouring of formulation in discs, discs are went through gravity coating area where grains fall upon disc from a container with require time interval. This is also known as primary coating. Disc are being coated in this section with the help of 3-ARM servo motor.

**ESU coating unit--** In esu(electro static unit) coating unit is the another layer of coating grains into the discs.. here grains are going through one conveyor and discs are going through one suction drums. Every time conveyor grains are lifting through step up transformers(18kv peak voltage).

**Disc unloading unit--** After completion of esu coating discs are unloaded in this area through traveller cylinder and goes for next level process.

**Oven for curing--** After formulation coating disc passes through chain conveyor in oven zone for curing at the temp of 110c.In oven zone 7 sections present for step by step curing

**Sizer unit--** Sizer unit is mainly for colour coating on disc as per finishing product requirement and remove the stiffness of product. Sizer unit is same like maker unit.

**[6] Modification—**

**Modification in PLC wiring--** Modification done in the gravity and esu coating section.. both having conveyor and its taking grains for disc coating purposes . but using of lots of cylinder , motor and pneumatic pump both sections turned into huge vibrations. As per vibration grains usually fall down from the both of conveyor. In that time if conveyor goes to opposite direction then the grains from ending portion of conveyor won't fall down. And it will be helpful for increase the production uptime as well as productivity. Because it can help to reduce time of grit changing as well as reduce the cleaning time for production.

Modification done in control wiring as well as plc programming. Allen bradely 1756 plc has used for control wiring and simulation done in logixpro .

POWER DISTRIBUTION DIAGRAM:

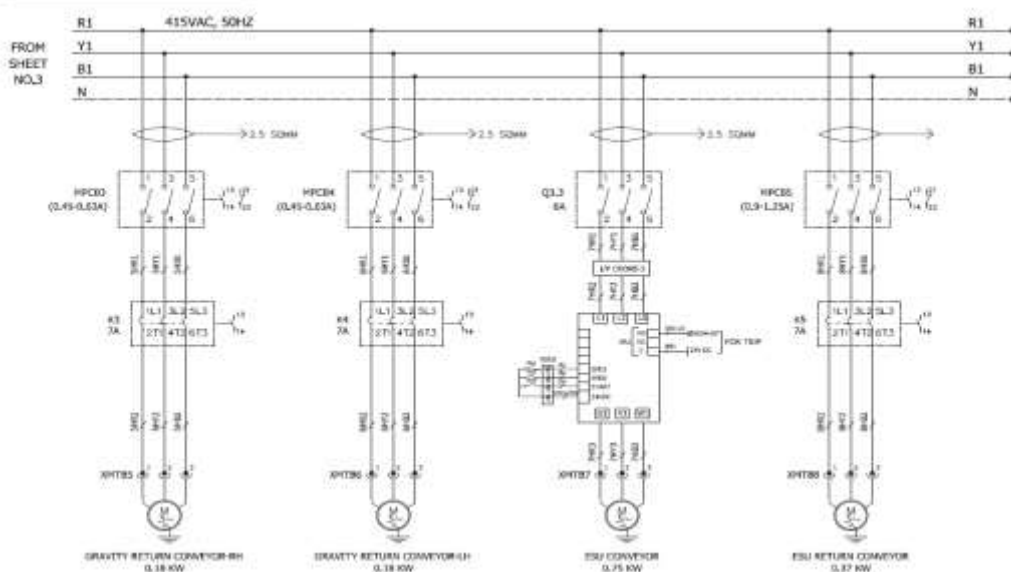

Fig : power distribution diagram of pre modified gravity conveyor

**Modified diagram--**

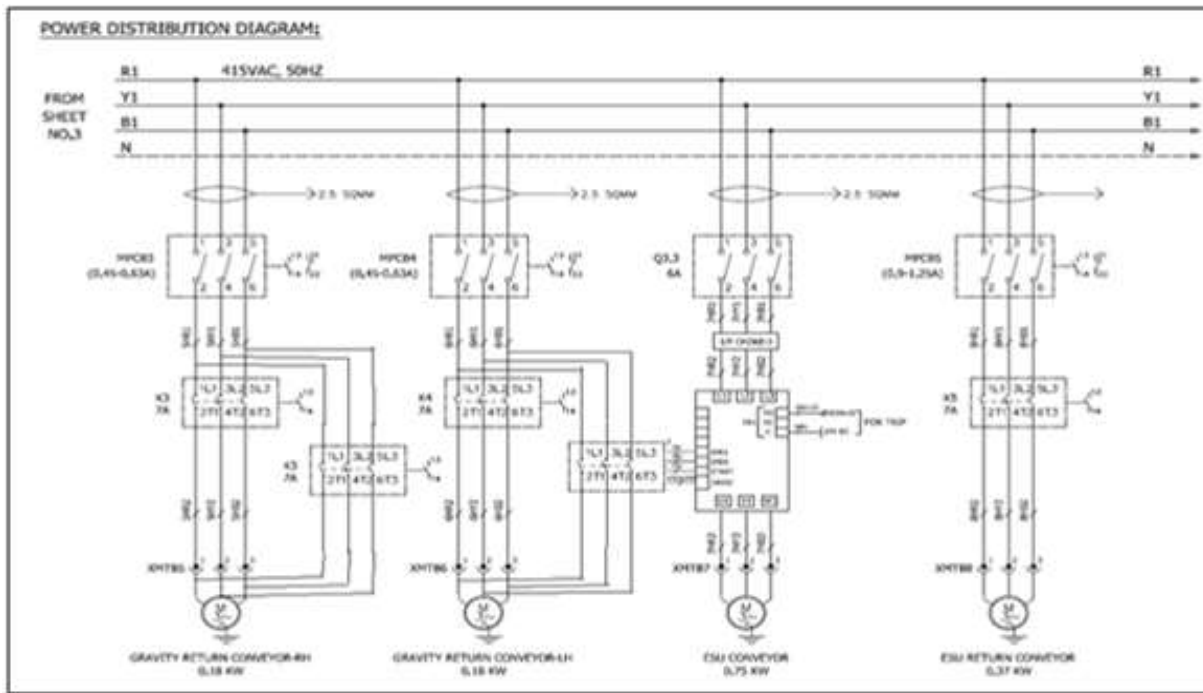

Fig :: power distribution diagram of modified gravity coater conveyor

[7] PLC design and coding--

I:1/0	Forward Start	Input
I:1/1	Reverse Start	Input
I:1/2	Stop	Input
O:2/14	Latched coil 1 for forward direction	Output
O:2/0 & O:2/1	Forward Contactor	Output
T4:1	Delay before forward direction	Timer
O:2/15	Latched coil 2 for reverse direction	Output
O:2/2 & O:2/3	Reverse Contactor	Output
T4:0	Delay before reverse direction	Timer

Fig :: i/o table

Simulation logic for forward and reverse the conveyor in logixpro--

Step 1--



Step 2--

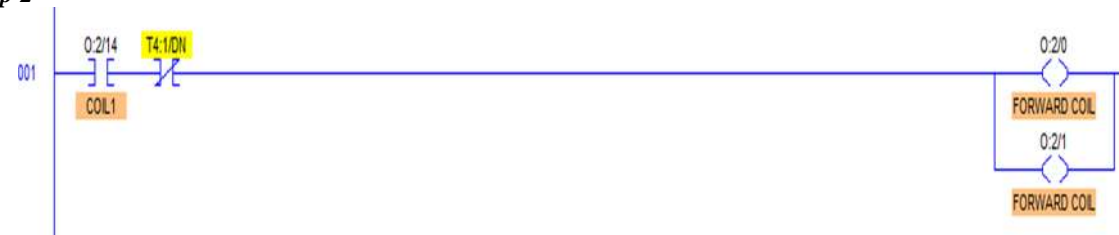

Step 3--

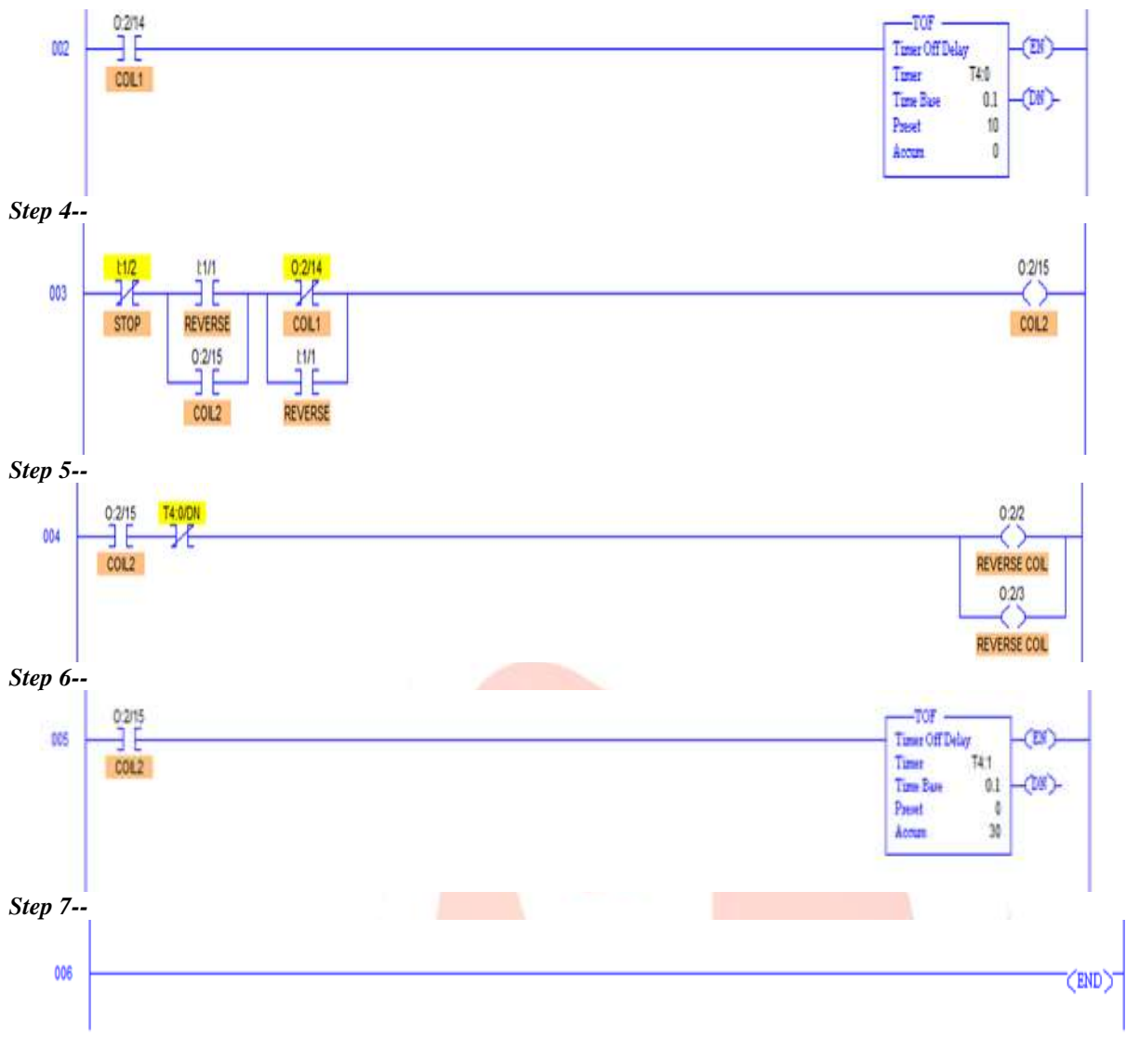

### III. RESULTS & DISCUSSION

This project deals with the production uptime as well as production of abrasive coated discs. The high speed maker, oven and sizer section using plc 1756 series and supervisory control and data acquisition(SCADA) HMI. By studying all the cases modifying PLC automation we get an accuracy of 99% when we compare with other control system or production modification.

**[1] Pre modification condition disadvantages--** After every required production need to change grit for next specified product and also cleaning of line is very necessary.. because different product having different formulation and different sizes.

As per production uptime grit changing should taken 90 mins. In this time formulation need to change and clean the equipments as all over its covered by grains. For next product need to pour grains in conveyor container of gravity and esu coating area. If by mistaken grains mixed with each other , it affects on product quality .

So cleaning of extra fallen grains also took minimum 20 mins to clean. By implementing the project the grit changing time has reduced from 90 mins to 70 mins.

So quantity loss of disc is also a factor

And also time loss is another issue.

**[2] Advantages of modification on control panel through PLC--**

Easily programmed and have an easily understood programming language.

As increased production uptime, it also increase the plant uptime

Plant Uptime = plant run time (production) / Total available time to run or produce

Reduction in production time-having a machine that fully automated definitely speeds up the production time.

Increase in accuracy and repeatability function of both conveyor as it is programmed to perform the right task over and over

Less human error- as no one is perfect and human prone to making mistake.but machine performs repeated tasks is less likely to mistake than human.

Less employee cost- as we know for that cleaning in the time between grit changing , need more manpower to clean and grit change at same time. But implementing this project it should be resolved.

Increased safety- during cleaning and grit changing , its dangerous to do work inside or surroundings machines. So implementation of this project also remove that safety issue



Higher volume production- implementing automation it reduce the grit changing time to not doing cleaning and saving time which is advantageous for production volume

**[3] Algorithm--**

Previously as per production data and HMI monitoring system,

Number of disc manufacture in one minutes= 32 nos  
 total running time in one day= 21 hrs=1260 mins  
 time taken for grit changing=90 mins  
 number of grit changing in one day= 5 times  
 so, total time taken for grit changing=(90×5)=450 mins  
 then total running time for disc manufacturing in one day=(1260-450)mins=810 mins  
 so, number of manufactured disc= (32×810)=25920 nos  
 as number of manufacturing lines are =3,  
 thus, total number of manufacturing disc=(25920×3)=77760 nos

After implementation of the project the following result

Number of disc manufacture in one minutes= 32 nos  
 total running time in one day= 21 hrs=1260 mins  
 time taken for grit changing=70 mins(as 20 mins for cleaning times have reduced by implementing the project)  
 number of grit changing in one day= 5 times  
 so, total time taken for grit changing=(70×5)=350 mins  
 then total running time for disc manufacturing in one day=(1260-350)mins=910 mins  
 so, total number of manufactured disc= (32×910)=29120 nos  
 as number of manufacturing lines are =3,  
 thus, total number of manufacturing disc=(29120×3)=87360 nos

**[4] Graph--**

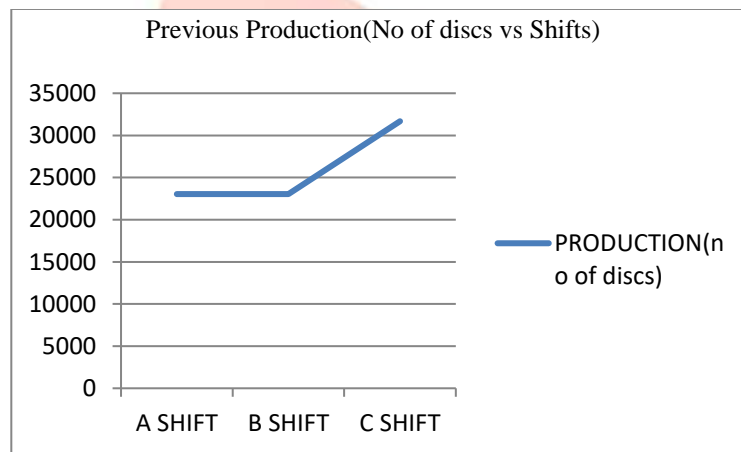

Fig: previous production of discs

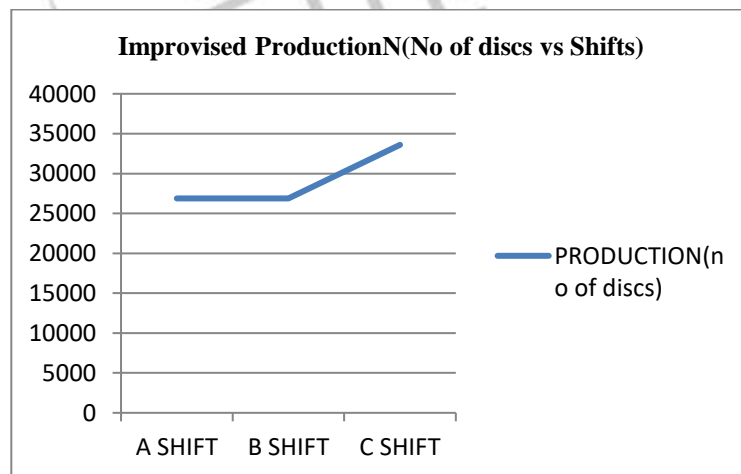

Fig: production of discs after modification

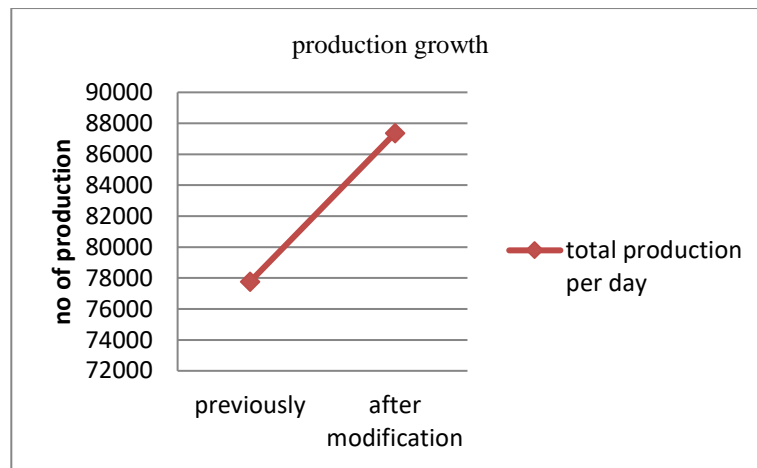

Fig: production growth after modification

#### IV. CONCLUSION

By using PLC and SCADA in industries we can increase the production, quality and quantity. energy saving, less maintenance & accuracy is good when compare to other automation like relay logic control and micro processor.

The old PLC modified as per the required I/O for PLC automation in coated disc abrasive manufacturing plant. The designed ladder programs are tested by implementing a real time application program with a simulation data and it proves a good response time.

This project deals with the production uptime as well as production of abrasive coated discs. The high speed maker, oven and sizer section using plc 1756 series and supervisory control and data acquisition(SCADA) HMI. By studying all the cases modifying PLC automation we get an accuracy of 99% when we compare with other control system or production modification. By using PLC and SCADA in industries we will increase the production, Quality and quantity, energy saving, less maintenance accuracy is good When compare to other automation like relay logic control and microprocessor.

#### V. REFERENCES

- [1] E. A. Parr, Industrial Control Handbook, Industrial Press Inc., 1999
- [2] M. A. Laughton, D. J. Warne (ed), Electrical Engineer's Reference book, 16th edition, Newnes, 2003 Chapter 16 Programmable Controller
- [3] Programmable Logic Controllers, Fifth Edition, Newnes, 2009 ISBN 978-1-85617-751-1
- [4] Vosough and Vosough (November 2011). "PLC and its Applications
- [5] Websites: <http://www.sanfoundry.com/plc-program-drive-motor-forward-reverse-direction/>
- [6] [www.ijoaart.org/docs/Conveyor-Control-Using-Programmable-Logic-Controller.pdf](http://www.ijoaart.org/docs/Conveyor-Control-Using-Programmable-Logic-Controller.pdf)
- [7] <http://ab.rockwellautomation.com/programmable-controllers/controllogix>