

Review on evolution and future trends of fibre optics communication

INisha Jha
 I Assistant Professor
 Imrcet

Abstract - In this digital era, predominated by fast to and fro communication, nothing can be smart with the smart gadgets unless a support fast paced internet connection is available. Unless you are an occasional internet user, a high-speed broadband connection would always be your priority and this is where Fibre Optics Broadband comes to picture, as with its high-speed capability, it has ventured into mainstream utilization. Fibre optic systems are important telecommunication infrastructure for world-wide broadband networks. Wide bandwidth signal transmission with low delay is a key requirement in present day applications. Optical fibres provide enormous and unsurpassed transmission bandwidth with negligible latency, and are now the transmission medium of choice for long distance and high data rate transmission in telecommunication networks. Here, I have given a brief review of this latest minefield with definition, including their key technologies, and also discusses their technological trend towards next generation.

keywords - Bandwidth, Broadband, Fibre optics, Latency, Telecommunication

INTRODUCTION

A society moves into the information age, with increasing demand for high speed data links to information located across the globe, a push has been made to develop transmission system that might handle the demands of future. Fibre optics is hybrid field. The basic concept of fibre is optical and fibre bundles are used as optical component. The working of optical fibre depends on basic properties of optics and interaction of light with matter.[1] From physical point of view light can be seen as electromagnetic waves or photon, which is a quantum of electromagnetic energy. It considered light as rays travelling in a straight line between optical elements which can reflect or bend. Light is only a small part of electromagnetic radiation. Most of the optical fibres used transmit light in the near infrared light at wavelength of 800-600nm. Modern optical networks feature transmission links that can reach high data-capacity on a single fibre by combining many wavelengths, operating at rates as high as 100 Gigabytes per second onto a single fibre. Optical communications historically has specialized in the transmission of large amounts of data over long distances [2].

It is widely used for telephony, internet traffic, LANs, cable T.V etc. In optical Fibre a single silica fibre can carry hundreds of thousands of telephone channels, utilizing only a small part of the theoretical capacity. Day by day so many new technologies emerging such as CDMA, GSM, Wi Max, etc. Within the last 40 years, the transmission capacity of optical fibres has been increased enormously [3].

Many new classes of optical communication networks are presently emerging. For example, Code Division Multiple Access networks using optical signal processing techniques have recently being introduced .Despite the associated benefits of utilizing optical fibre for communication (such as its high reliability over long distances, low attenuation, low interference, high security, very high information capacity, longer life span and ease of maintenance), research is still ongoing to further improve on the present fibre optics communication system, and also to solve some of the challenges facing it.[4] Future optical communication systems are envisioned to be more robust than the present system. This paper is organized as follows. Section II describes the basic principles of fibre optics communication. Section III looks at the history and evolution of fibre optics communication while section IV gives future trends in fibre optics communication, in section V we draw the conclusion for the paper.

II. BASIC PRINCIPLE OF FIBRE OPTICS COMMUNICATION

a) Connectivity

Optical fibre is the medium in which communication signals are transmitted from one location to another in the form of light guided through thin fibre of glass or plastic. These signals can be digital pulses or continuously modulated analogue stream of light representing information like voice, data [12].

Basically optical fibre made of three elements i.e. as shown in figure.1

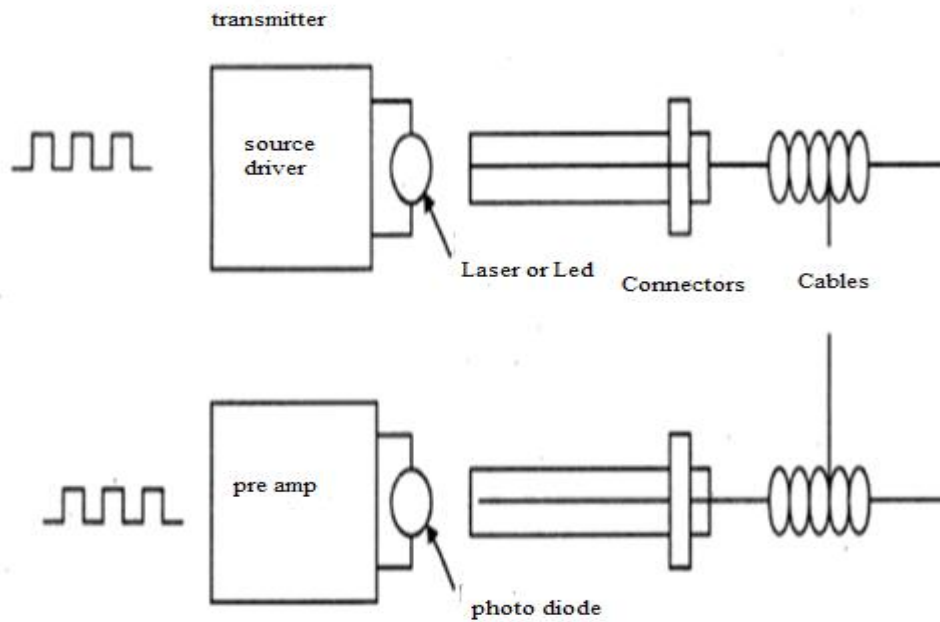

Fig.1

A Light source at one end (laser or led) along with connectors is to connect the fibre. Light source receive the signal from driver and electrical signal into optical signal. Fibre along with cable connectors transports this signal to destination. On the other hand photo diode along with connectors interface to the fibre and detector converts light back to electrical signals. The Source and detector with necessary support electronics are called transmitter and receiver respectively. Hence it clear that fibre optic transmission is basically merging of two technology.

- 1. Semiconductor technology
- 2. Optical waveguide technology

Semiconductor technology develops the source and detector at longer wavelength i.e. 1.1-1.6µm., where as optical fibre technology relates to the fibre fabrication, transmission characteristics of fibre, fibre connection.

Types

Optical fibre can be basically divided into two categories...

Optical fibres can be classified based on either the mode they support or the refractive index profile of the fibre. They can also be classified based on the material of the fibre.

➤ **Based on Mode:**

The rays travelling in the fibre by total internal reflection are called modes.

Single mode fibres:

If the thickness of the fibre is so small that it supports only one mode then the fibre is called single mode fibre or mono mode fibre. The core diameter of this fibre is about 8 to 10µm and the outer diameter of cladding is 60 to 70µm.

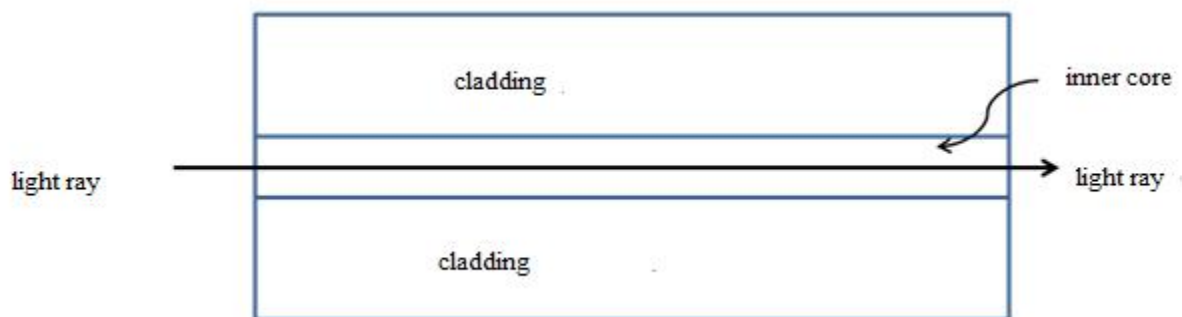

Fig.2

Multi mode fibres:

If the thickness of the fibre is very large that it supports more than one mode then the fibre is called multi mode fibre. The core diameter of this fibre is about 50 to 200µm and the outer diameter of cladding is 100 to 250µm.

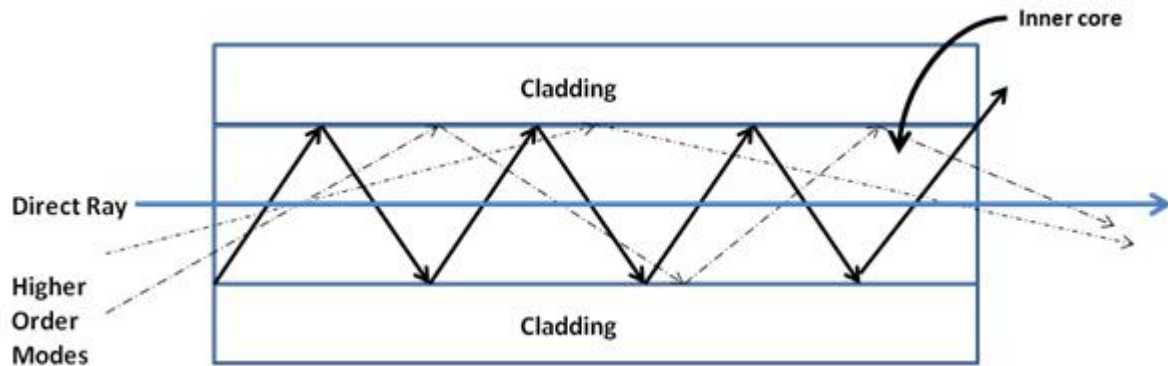

Fig.3

➤ **Based on refractive index profile:**
Step-Index Optical fibre:

In a step-index optical fibre, the entire core has uniform refractive index n_1 slightly greater than the refractive index of the cladding n_2 . Since the index profile is in the form of a step, these fibres are called step-index fibres. The transmission of information will be in the form of signals or pulses. These are extensively used because distortion and transmission losses are very less. Step-index optical fibres are of two types. They are

- (i) Single mode step-index fibre
- (ii) Multi-mode step-index fibre

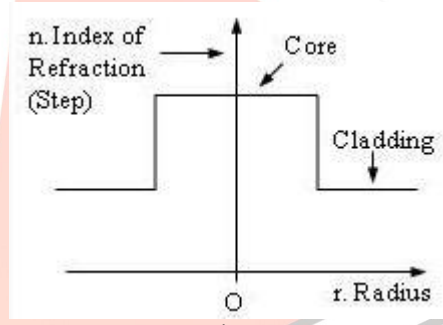

Fig.4

Graded index optical fibre:

In this fibre, the refractive index of the core varies radially. It has maximum refractive index at its centre, which gradually falls with increase of radius and at the core-cladding interface matches with refractive index of cladding. This fibre divided into two types.

- (i) Single-mode graded index fibre.
- (ii) Multi-mode graded index fibre.

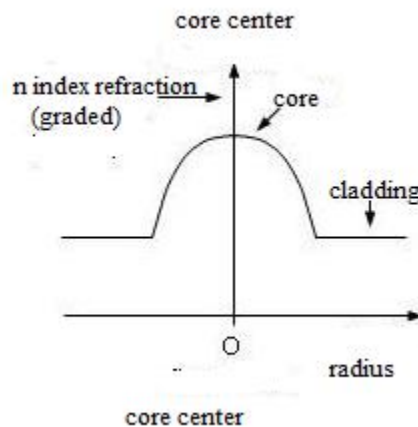

Fig.5

c) Basic element

A Fibre optic cable consists of four parts:

- Core
- Cladding
- Buffer
- Jacket

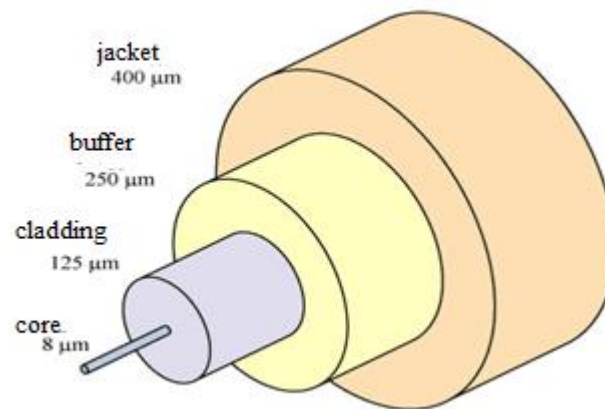

Fig.6

Core

The core of a fibre cable is a cylinder of plastic that runs all along the fibre cable's length, and offers protection by cladding. The diameter of the core depends on the application used. Due to internal reflection, the light travelling within the core reflects from the core, the cladding boundary. The core cross section needs to be a circular one for most of the applications.

Cladding

Cladding is an outer optical material that protects the core. The main function of the cladding is that it reflects the light back into the core. When light enters through the core (dense material) into the cladding (less dense material), it changes its angle, and then reflects back to the core.

Buffer

The main function of the buffer is to protect the fibre from damage and thousands of optical fibres arranged in hundreds of optical cables. These bundles are protected by the cable's outer covering that is called jacket.

Jacket

Fibre optic cable's jackets are available in different colours that can easily make us recognize the exact colour of the cable we are dealing with. The colour yellow clearly signifies a single mode cable, and orange colour indicates multimode.

d) Characteristics

In Optical fibre communication, light is used as a signal which transmitted inside the optical fibre cable. This mode of communication has characteristics which are important to be discussed and makes it a good mode of communication.

- **Bandwidth** – Single laser light dispersion means that a good amount of signal can be transmitted (Information being transferred in bits) per second which results in high bandwidth for long distances.
- **Smaller diameter** – The diameter of Optical fibre cable is about 300 micrometers in diameter.
- **Light-weight** – The Optical fibre cable is light in weight compared to the copper cable.
- **Long-distance signal transmission** – Since the laser light doesn't disperse, it can be easily transmitted over long distances.
- **Low attenuation** – The fibre is made of glass and laser is travelling through it, the signal transmitted has only 0.2 dB/km loss.
- **Transmission security** – Optical encryption and no presence of the electromagnetic signal make the data secure over optical fibre.

III. EVOLUTION OF OPTICAL FIBRE COMMUNICATION

a) Optical fibre was successfully developed in 1970 by Corning Glass Works, with attenuation low enough for communication purposes (about 20 dB/km) and at the same time GaAs semiconductor lasers were developed that were compact and therefore suitable for transmitting light through fibre optic cables for long distances. [6] In 1973, Optelecom, Inc., co-founded by the inventor of the laser, Gordon Gould, received a contract from APA for the first optical communication systems. Developed for Army Missile Command in Huntsville, Alabama, it was a laser on the ground and a spout of optical fibre played out by missile to transmit a modulated signal over five kilometres.

b) The second generation of fibre-optic communication was developed for commercial use in the early 1980s, operated at 1.3 μm and used InGaAsP semiconductor lasers. [7] These early systems were initially limited by multi mode fibre dispersion. By 1987, these systems were operating at bit rates of up to 1.7 Gb/s with repeater spacing up to 50 km (31 mi). [7]

c) Third-generation fibre-optic systems operated at 1.55 μm and had losses of about 0.2 db/km. This development was spurred by the discovery of Indium gallium arsenide and the development of the Indium Gallium Arsenide photodiode by Pearsall. [8] These developments eventually allowed third-generation systems to operate commercially at 2.5 Gbit/s with repeater spacing in excess of 100 km (62 mi) [7].

d) The fourth generation of fibre-optic communication systems used optical amplification to reduce the need for repeaters and wavelength-division multiplexing to increase data capacity.[8] These two improvements caused a revolution that resulted in the doubling of system capacity every six months starting in 1992 until a bit rate of 10 Tb/s was reached by 2001. In 2006 a bit-rate of 14 Tbit/s was reached over a single 160 km (99 mi) line using optical amplifiers [9].

e)The focus of development for the fifth generation of fibre-optic communications is on extending the wavelength range over which a WDM system can operate. The conventional wavelength window, known as the C band, covers the wavelength range 1.53–1.57 μm , and dry fibre has a low-loss window promising an extension of that range to 1.30–1.65 μm [14].

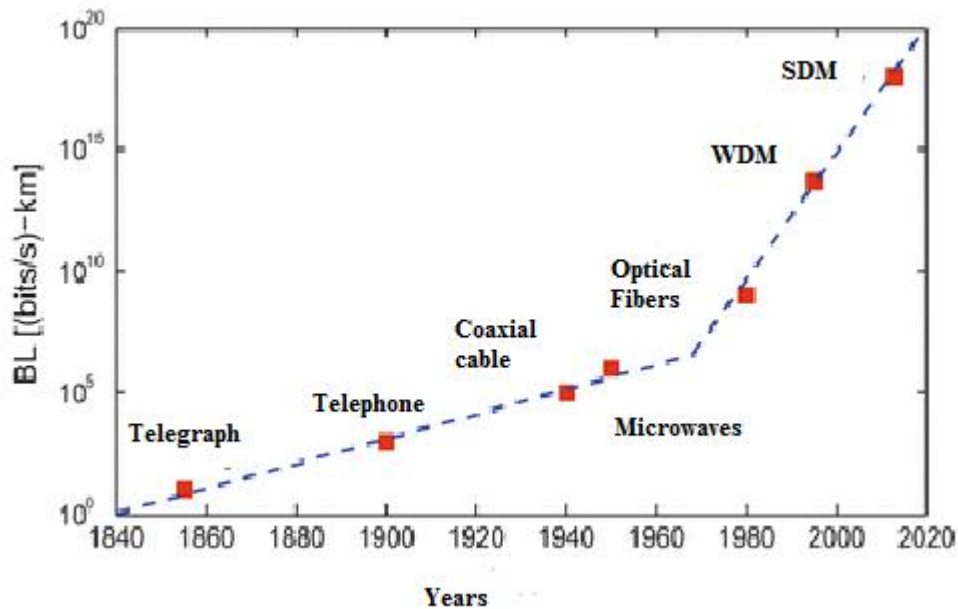

Fig.7 [14]

IV. FUTURE TRENDS OF OPTICAL FIBRE COMMUNICATION

Fibre optics communication is definitely the future of data communication. The evolution of fibre optic communication has been driven by advancement in technology and increased demand for fibre optic communication. It is expected to continue into the future, with the development of new and more advanced communication technology. Below are some of the envisioned future trends in fibre optic communication [15].

a) Optical Communication Networks

In this type of networks, all signals will be processed in the optical form, without using electrical manipulation. At present, processing and switching of signals must be in the electrical domain, optical signals must first be converted to electrical signal before they can be processed, and routed to their destination [9]. After the processing and routing, the signals are then re-converted to optical signals, which are transmitted over long distances to their destination. This optical to electrical conversion, and vice versa, results in added latency on the network and thus is a limitation to achieving very high data rates.

Another benefit of all optical networks is that there will not be any need to replace the electronics when data rate increases, since all signals processing and routing occurs in the optical domain [9]. However, before this can become a reality, difficulties in optical routing, and wavelength switching has to be solved. Research is currently ongoing to find an effective solution to these difficulties [9].

b) Multi – Terabit Optical Networks

DWDM opens the door to multi-terabit transmission. The interest in developing multi-terabit networks is driven through the increasing accessibility to more bandwidth in fibre optic networks. One terabit network was achieved by using 10GB/s data rate combined with 100 DWDM channels, while four terabit networks may be accomplished by combing 40GB/s data rate with 100 DWDM channels too. [10] Researchers move their target to even higher bandwidth with 100 GB/s systems. This kind of speed is extremely expensive for make and may just be justified on long-haul systems [14].

c) Optical Transmission Network with intelligence

At present, traditional optical networks are not able to adapt to the rapid growth of online data services due to the unpredictability of dynamic allocation of bandwidth, traditional optical networks rely mainly on manual configuration of network connectivity, which will be time consuming, and unable to fully adapt to the demands of the modern network. Intelligent optical network is a future trend in optical network development, and it will have the following applications: traffic engineering, dynamic resource route allocation, special control protocols for network management, capabilities, bandwidth on demand, wavelength rental, wavelength wholesale, differentiated services for a variety of Quality of Service levels etc.[11] This will take some time before the intelligent optical network can be applied to all levels of the network, it will first be applied in long-haul networks, and then it will be applied to the network edge.

d) Ultra – Long Haul Optical Transmission

In this area, the limitations imposed due to imperfections in the transmission medium are subject for research. Cancellation of dispersion effect has prompted researchers to study the potential benefits of solution propagation. More understanding of the interactions between the electromagnetic light wave and the transmission medium is necessary to proceed towards an infrastructure with the most favourable conditions for a light pulse to propagate. [14]

e) Improvements in Laser Technology

There is wide application in laser technology. This future trend will be the extension of present semiconductor lasers to a wider variety of lasing wavelengths. Shorter wavelength lasers with very high output powers are of interest in some high density optical applications. Presently, laser sources which are spectrally shaped through chirp managing to compensate for chromatic dispersion are available. Chip managing means that the laser is controlled such that it undergoes a sudden change in its wavelength when firing a pulse, such that the chromatic dispersion experienced by the pulse is reduced. There is need to develop instruments to be used to characterize such lasers. Also, single mode tuneable lasers are of great importance for future coherent optical systems [14].

f) Laser Neural Network Nodes

The laser neural network is an effective option for the realization of optical network nodes. A dedicated hardware configuration working in the optical domain and the use of ultra-fast photonic sections is expected to further improve the capacity and speed of telecommunication networks. As optical networks become more complex in the future, the use of optical laser neural nodes can be an effective solution [14].

g) Polymer Optic Fibres

Polymer optical fibres offer many benefits when compared to other data communication solutions such as copper cables, wireless communication systems, and glass fibre. In comparison with glass optical fibres, polymer optical fibres provide an easy and less expensive processing of optical signals, and are more flexible for plug interconnections. [15]The use of polymer optical fibres as the transmission media for aircrafts is presently under research by different Research and Development groups due to its benefits.[11] The German Aerospace Centre has concluded that “the use of Polymer Optical Fibres multimedia fibres appears to be possible for future aircraft applications. Also, in the future, polymer optical fibres will likely displace copper cables for the last mile connection from the telecommunication company’s last distribution box and the served end consumer. The future Gigabit Polymer Optical Fibre standard will be based on Tomlinson-Harishima Precoding, Multilevel PAM Modulation, and Multilevel Cosset Coding Modulation. [15]

V. CONCLUSION

Until recently all communication systems have relied on the transmission of information via electrical cables or have made use of radio frequency and microwave electromagnetic radiation propagating in free space. However, optical communication is now coming into its own and is becoming the preferred technology in many applications. . There is still much work to be done to support the need for faster data rates, advanced switching techniques and more intelligent network architectures that can automatically change dynamically in response to traffic patterns and at the same time be cost efficient.

VI. REFERENCES

- [1] Fidanboyly, K.a, * , and Efendioglu, H. S.b a, * Fatih University, Istanbul, Turkey, Fatih University, Istanbul, Turkey, 5th International Advanced Technologies Symposium (IATS’09), May 13-15, 2009,Karabuk, Turkey” fibre optic sensors and their applications”
- [2] Sylvain Lecler and Patrick Meyrueis Strasbourg University France” Intrinsic Optical Fibre Sensor”
- [3] FBG - Fibre Bragg Grating principle
- [4] M.Poovizhi , International journal of advance research trend in engineering and technology in fibre optics communication.
- [5] M. Noshada, A. Rostami, “FWM minimization in WDM optical communication systems using the asymmetrical dispersion managed fibres”, International Journal for Light and Electron Optics, vol. 123, no. 9, pp. 758– 760, 2012.
- [6] X. Wang and K. Kitayama, "Analysis of beat noise in coherent and incoherent time-spreading OCDMA," IEEE/OSA Journal of Lightwave Technology ,vol. 22, no. 10, pp. 2226-2235, 2004.
- [7] T. H. Shake, "Confident performance of encoded optical CDMA", IEEE/OSA Journal of Lightwave Technology, vol. 23, pp. 1652- 1663, 2005.
- [8] Prachi Sharma et al, “A Review of the Development in the Field of Fibre Optic Communication Systems”, International Journal of Emerging Technology and Advanced Engineering, Vol. 3, no. 5, pp. 113-119, 2013.
- [9] Colin Yao, “The Future of Fibre Optic Communication”, available at: www.streetdirectory.com, 2013.

- [10] “Status of Optical Communication Technology and Future Trends”, available at: www.qqread.net, 2013.
- [11] Djan Kloe, Henrie Van Den Boom, “Trends in Electro-optical Communication Systems, Perspectives on Radio Astronomy: Technologies for Large Antenna Arrays, Proceedings of the Conference held at the ASTRON Institute in Dwingeloo on 12-14 April 1999. Edited by A. B. Smolders and M. P. Haarlem. Published by ASTRON. ISBN: 90-805434-2-X, 354 pages, 2000., p.2851999.
- [12] Pamela L. Derry, Luis Figueroa, Chi Shain Hong, “Semi-Conductor Lasers”, 1991.
- [13] U.H.P. Fischer, M.Haupt and M.Janoic, “Optical Transmission Systems Using Polymeric Fibres”, In Tech, available from:
- [14]Google scholar.
- [15]Wikipedia

