

Shunt Active Power Filter for Power Quality Improvement in Distribution Systems

Arpit Shah

Department of Electrical Engineering
Parul Institute of Engineering and Technology
Vadodara, India
arpit_shah91@yahoo.co.in

Nirav Vaghela

Department of Electrical Engineering
Parul Institute of Engineering and Technology
Vadodara, India
nmv.elect@gmail.com

Abstract—The excessive of power electronics devices in distribution system has evolved the problem of power quality. Arc Furnaces, Variable Frequency Drives (VFD), Computer power supplies play major role in the deterioration in the quality power by injecting harmonics in the utility supply source. This paper represents the effective solution of shunt active power filter for eliminating the harmonics to maintain the quality of utility power supply. In the proposed scheme shunt active filter acts as a current source and eliminates harmonics by injecting equal but opposite harmonics components at the point of common coupling. Simulation of shunt active filter based on instantaneous reactive power theory is carried out using MATLAB-Simulink Toolbox. To prove the flexibility and effectiveness of the proposed scheme two types of loads have been considered and simulation results are observed.

Index Terms— Power Quality, Shunt Active Power Filter, Instantaneous reactive power theory, Hysteresis current control.

I. INTRODUCTION

Use of non linear harmonic producing loads in the distribution system creates power quality problems for power engineers. The use of power electronics devices at the end user side is increasing tremendously because of the advancements in the semiconductor technology. The use of power electronics devices gives rise to problems like harmonic generation, poor power factor, reactive power disturbance, low system efficiency, disturbance to other consumer, heating of devices, etc. This adverse may becomes sizable in future year, hence it is very important mitigate this problems.

Basically there are two approaches for the mitigation of power quality problems. The first approach is load conditioning, which ensures that the load is immune harmonics. Equipments are made less sensitive to harmonics and power disturbance, which is not so possible practically. The other solution is power line conditioning. In this approach line conditioning system is installed at point of common coupling (PCC) that suppresses or counteract for the adverse effect produced by non linear harmonic producing loads.

Traditionally passive filters were used to deal with harmonic generation and reactive power disturbance problems. But they were facing major drawbacks like resonance problem, large size, fixed compensation characteristics, effect of source

impedance on performance etc. so this solution became less attractive. Subsequently the concept of active power filter was introduced by Sasaki and Machida in 1971. Active power filters gives effective solution compared to conventional

passive filters for the mitigation of harmonic and reactive power disturbance problems.

II. ACTIVE POWER FILTERS

Active power filters is the device which generate the same amount of harmonic as generated by the load but 180° phase shifted. So when these harmonics are inserted into the line at the point of common coupling the load current harmonics are eliminate and utility supply becomes sinusoidal. There are basically two types of active filter: Series active filters and shunt active filters.

Fig. 1 shows the basic scheme of shunt active power filter which compensate load current harmonics by injecting equal but opposite harmonic compensating current.

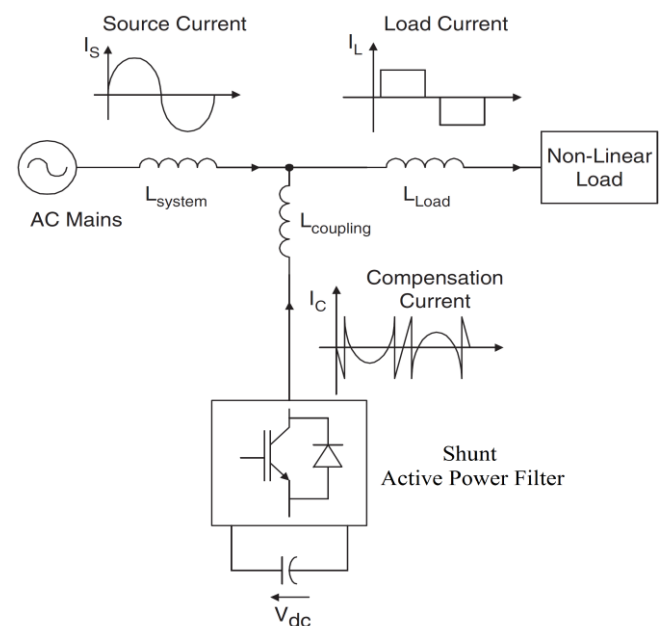

Fig. 1 Basic scheme of shunt active power filter

Basically shunt active power filter operates as a current source injecting the harmonic components generated by the load but phase shifted by 180° . As shown in Fig.2 series active power filters operate mainly as a voltage regulator and as a harmonic isolator between the nonlinear load and the utility source.

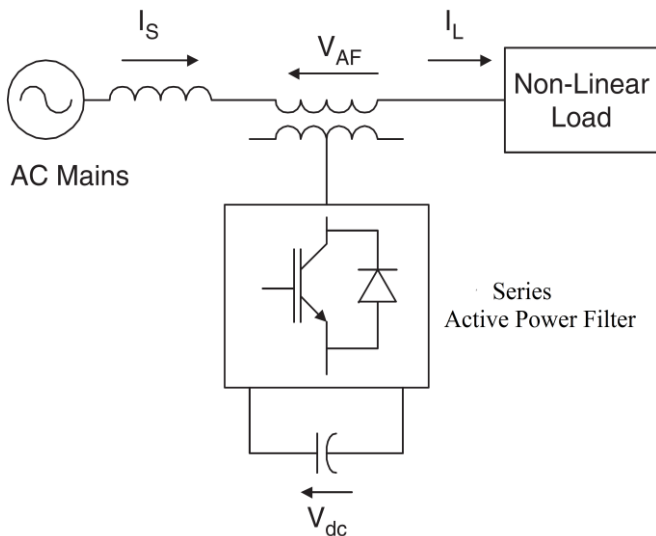

Fig. 2 Basic scheme of series active power filter

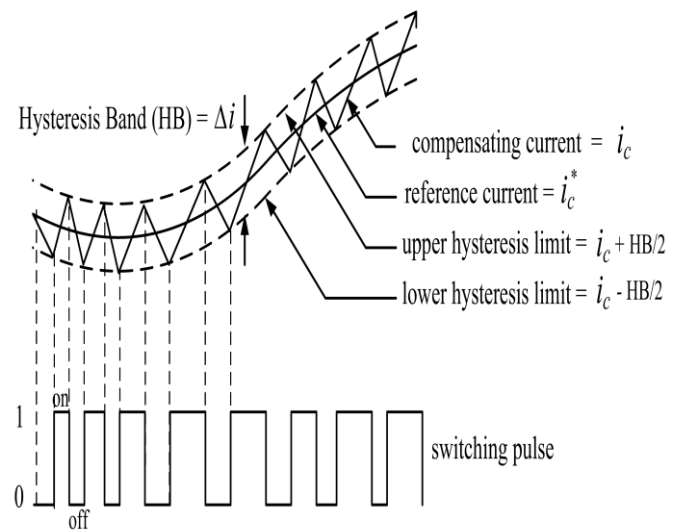

Fig. 3 Principle of hysteresis current control technique

The series active filter injects a voltage component in series with the supply voltage and removes harmonic components in voltage waveforms and therefore can be regarded as a controlled voltage source, compensating voltage sags and swells on the load side. Practically shunt active power filter are more effective and cheaper compared to series active power filters because most of the non linear loads produce current harmonics. Moreover series active power filter requires adequate protection scheme. The combined series and shunt active filter is called as Unified Power Quality Conditioner (UPQC).

III. HYSTERESIS CURRENT CONTROL TECHNIQUE

Hysteresis Current Control (HCC) technique is basically an instantaneous feedback current control method of PWM, where the actual current continually tracks the command current within a hysteresis band. Basic working principle of the HCC technique is shown in Fig. 3.

Hysteresis band (HB) is the possible boundary of the compensating current. This current deviates between upper and lower hysteresis limits. For example in phase *a*, if i_{ca} is equal or over than the upper hysteresis limit ($i_{ca}^* + HB/2$) then the comparator output is 0 ($S1=0, S2=1$). On the other hand, if i_{ca} is equal or less than the lower hysteresis limit ($i_{ca}^* - HB/2$) then the comparator output is 1 ($S1=0, S2=1$). From this operating, the i_{ca} can deviate inside the hysteresis band following the reference current i_{ca}^* . The main advantage of hysteresis current control method is excellent dynamic response, easy implementation and low cost.

Fig.4 shows the basic scheme of generation of six pulses to drive the six switches of inverter of shunt active power filter. In this method the actual output current generated by inverter is compared with reference current generated using instantaneous reactive power theory. Hysteresis current controller will generate pulses in such a manner that inverter output current will follow the reference current.

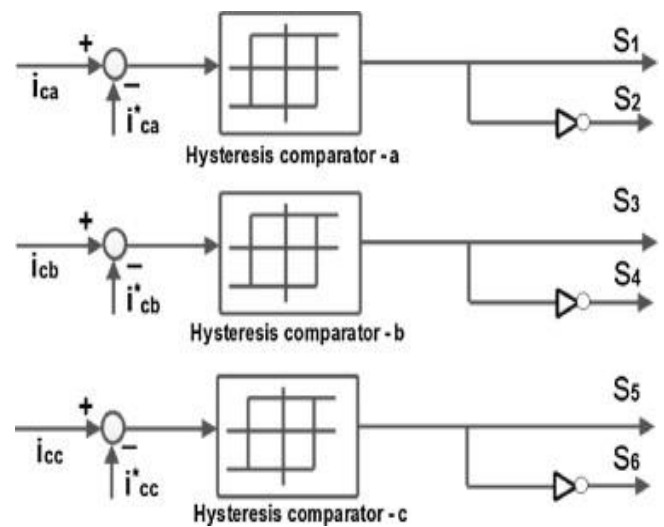

Fig. 4 Pulse generation using hysteresis current control technique

IV. INSTANTANEOUS REACTIVE POWER THEORY

The *p-q* theory was proposed by Akagi et al. in 1983. The *p-q* theory is based on conversion of *a-b-c* coordinate into $\alpha\text{-}\beta\text{-}0$ coordinates and $\alpha\text{-}\beta\text{-}0$ coordinates into *a-b-c* coordinates, popularly known as Clark transformation and inverse transformation respectively. Basic block diagram of *p-q* theory is shown in Fig. 8. Generated compensating current will be:

$$I_{comp} = I_{source} - I_{load} \tag{1}$$

Where,

I_{comp} = Compensating current

I_{source} = Source current and

I_{load} = Load Current

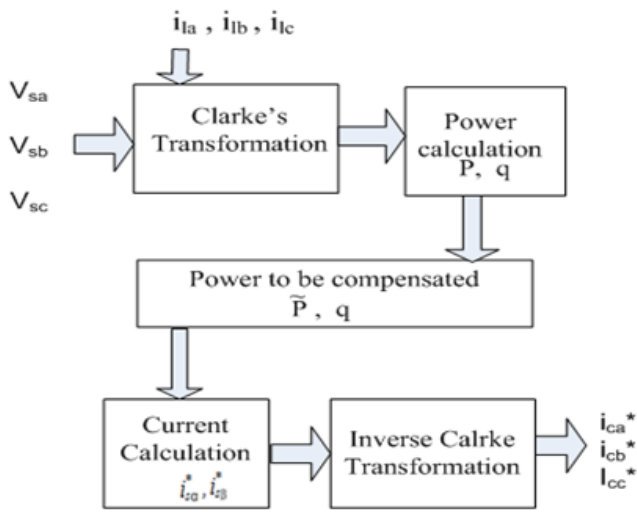
 Fig. 5 Basic block diagram of p - q theory

In this method three phase source voltage and load current are converted into α - β -0 stationary reference frame.

$$\begin{bmatrix} V_0 \\ V_\alpha \\ V_\beta \end{bmatrix} = \sqrt{\frac{2}{3}} \begin{bmatrix} \frac{1}{\sqrt{2}} & \frac{1}{\sqrt{2}} & \frac{1}{\sqrt{2}} \\ 1 & \frac{1}{2} & -\frac{1}{2} \\ 0 & \frac{\sqrt{3}}{2} & -\frac{\sqrt{3}}{2} \end{bmatrix} \begin{bmatrix} V_{sa} \\ V_{sb} \\ V_{sc} \end{bmatrix} \quad (2)$$

$$\begin{bmatrix} I_0 \\ I_\alpha \\ I_\beta \end{bmatrix} = \sqrt{\frac{2}{3}} \begin{bmatrix} \frac{1}{\sqrt{2}} & \frac{1}{\sqrt{2}} & \frac{1}{\sqrt{2}} \\ 1 & \frac{1}{2} & -\frac{1}{2} \\ 0 & \frac{\sqrt{3}}{2} & -\frac{\sqrt{3}}{2} \end{bmatrix} \begin{bmatrix} I_{sa} \\ I_{sb} \\ I_{sc} \end{bmatrix} \quad (3)$$

From this transformed quantities, instantaneous real and reactive power of the load is calculated which consists of average and oscillating component.

$$\begin{bmatrix} P_0 \\ P \\ q \end{bmatrix} = \begin{bmatrix} V_0 & 0 & 0 \\ 0 & V_\alpha & V_\beta \\ 0 & -V_\beta & V_\alpha \end{bmatrix} \begin{bmatrix} I_0 \\ I_\alpha \\ I_\beta \end{bmatrix} \quad (4)$$

For three phase three wire systems $I_0 = 0$, so source power P_0 also becomes zero. So power equation becomes as follows.

$$\begin{bmatrix} P \\ q \end{bmatrix} = \begin{bmatrix} V_\alpha & V_\beta \\ -V_\beta & V_\alpha \end{bmatrix} \begin{bmatrix} I_\alpha \\ I_\beta \end{bmatrix} \quad (5)$$

Instantaneous active and reactive power of load can be calculated as follows:

$$\begin{bmatrix} P_l \\ q_l \end{bmatrix} = \begin{bmatrix} V_\alpha & V_\beta \\ -V_\beta & V_\alpha \end{bmatrix} \begin{bmatrix} I_{l\alpha} \\ I_{l\beta} \end{bmatrix} \quad (6)$$

Instantaneous real and reactive power can be decomposed into two components called oscillatory

components and average components. Considering completely balanced and sinusoidal main supply conditions average power components represents first harmonic current of positive sequence and oscillatory components are related to all high order harmonic components including first harmonic current of negative sequence. So the shunt active filter should compensate for oscillatory power components, as a result of which average power components remains same in the main supply.

$$\begin{bmatrix} I_{s\alpha} \\ I_{s\beta} \end{bmatrix} = \frac{1}{V_\alpha^2 + V_\beta^2} \begin{bmatrix} V_\alpha & -V_\beta \\ V_\beta & V_\alpha \end{bmatrix} \begin{bmatrix} P \\ 0 \end{bmatrix} \quad (7)$$

The oscillating component is extracted using high-pass filter and taking inverse of α - β transformation compensating reference signals in terms of either currents or voltages are derived.

$$\begin{bmatrix} I_{ca}^* \\ I_{cb}^* \\ I_{cc}^* \end{bmatrix} = \sqrt{\frac{2}{3}} \begin{bmatrix} 1 & 0 \\ -\frac{1}{2} & \frac{\sqrt{3}}{2} \\ -\frac{1}{2} & -\frac{\sqrt{3}}{2} \end{bmatrix} \begin{bmatrix} I_{s\alpha} \\ I_{s\beta} \end{bmatrix} \quad (8)$$

V. SIMULATION RESULTS AND ANALYSIS

Performance of shunt active power filter is checked with the use of MATLAB software. In the proposed scheme two types of loads have been considered as nonlinear loads: (i) Resistive rectifier load and (ii) Inductive rectifier load. Fig. 6 shows the performance of shunt active power filter under resistive rectifier load. In this case the before the insertion of the shunt active power filter, Total Harmonic Distortion (THD) of source current was 27.17 % and after the insertion it comes down up to 1.02 %. Similarly for inductive rectifier load, THD of source current before insertion of was 25.82 % and after the insertion of shunt active filter it reaches to 2.46 %. Output result of source current for this case is shown in fig. 11. The shunt active filter was inserted at 0.06 second in both the cases. Moreover, comparison of effective elimination of low order harmonics is shown in Fig. 13 and Fig. 15.

A. For Rectifier R Load

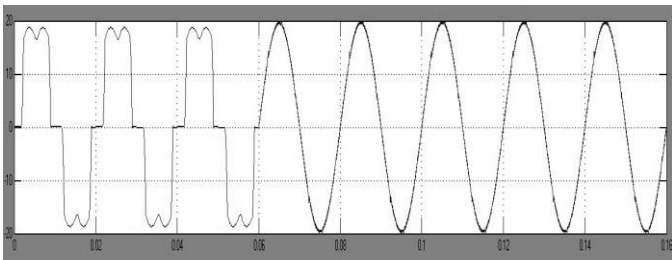

Fig. 6 Source current

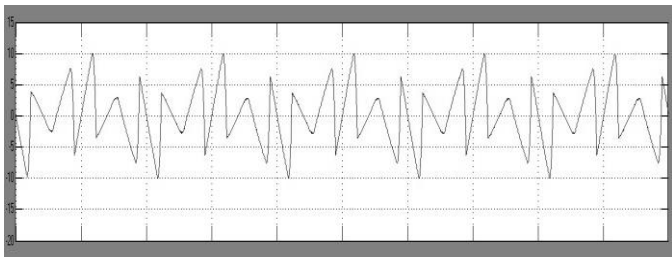

Fig. 7 Compensating current

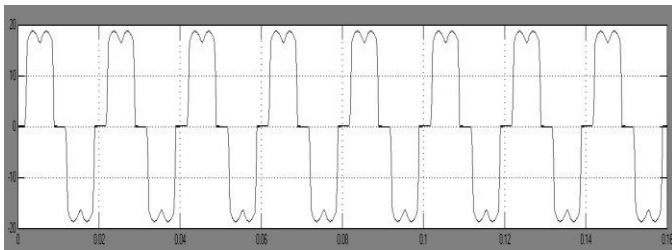

Fig. 8 Load current

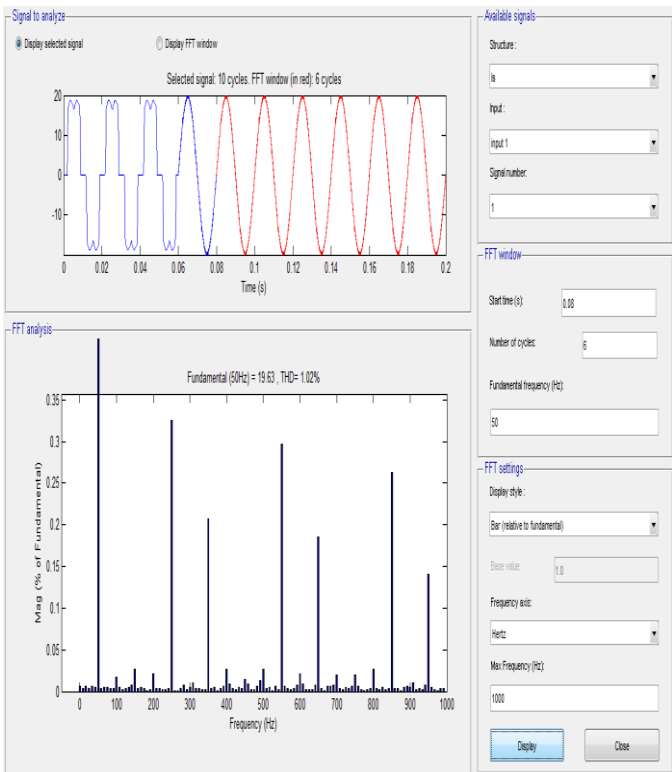

Fig. 9 FFT analysis of source current

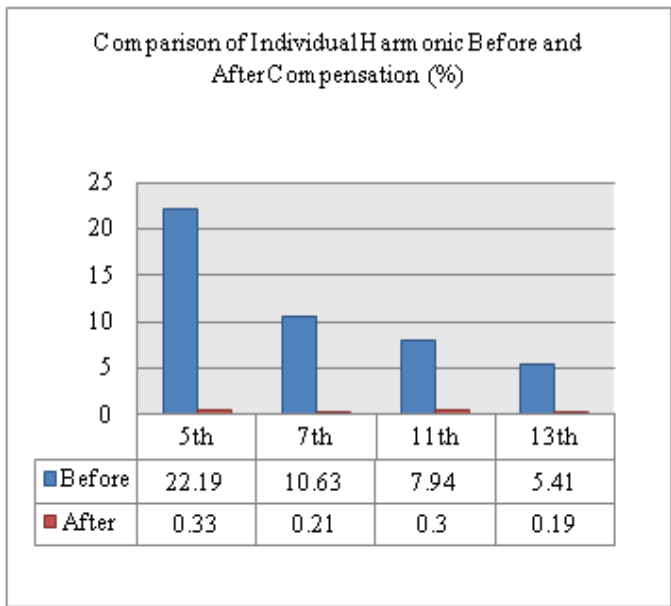

Fig. 10 Comparison of individual harmonics for Rectifier R load

B. For Rectifier R Load

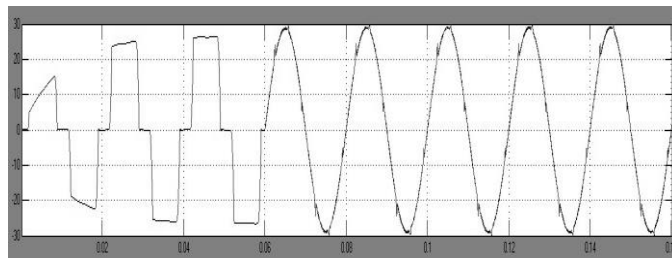

Fig. 11 Source current

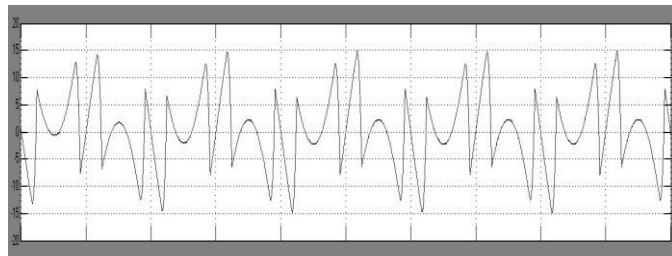

Fig. 12 Compensating current

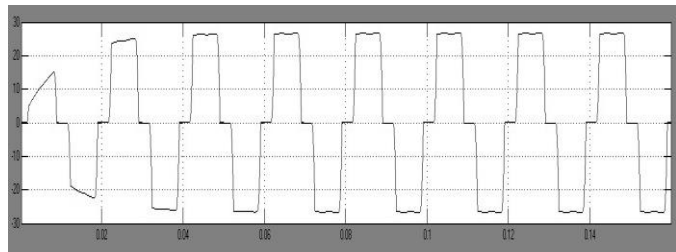

Fig. 13 Load current

Fig. 6 and Fig. 11 show the source current waveform before and after the insertion of shunt active power filter. From which it is observed that until the shunt active power filter is applied to the system, the source current is highly distorted. But once the shunt active power filter is applied to the line the shunt active power filter inject 180° phase shifted load current harmonics into the line and source current becomes very much near the ideal sinusoidal waveform.

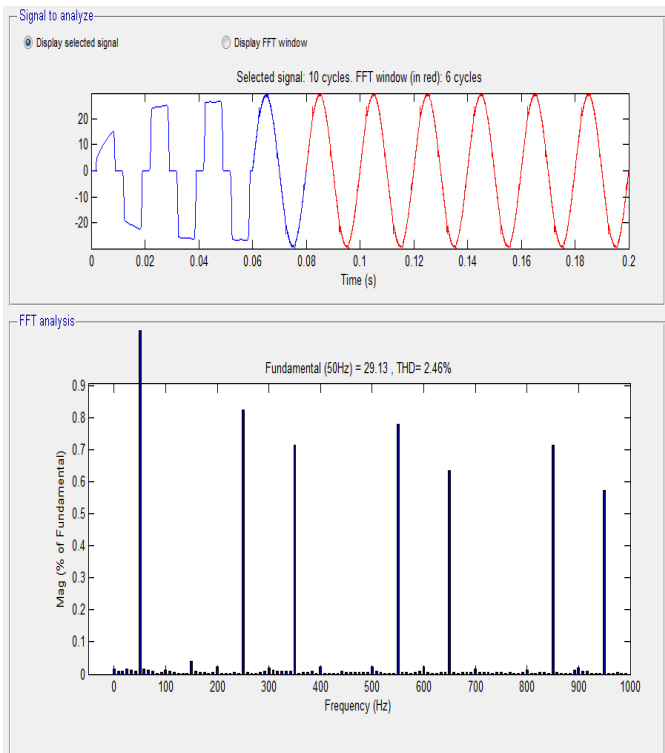

Fig. 14 FFT analysis of source current

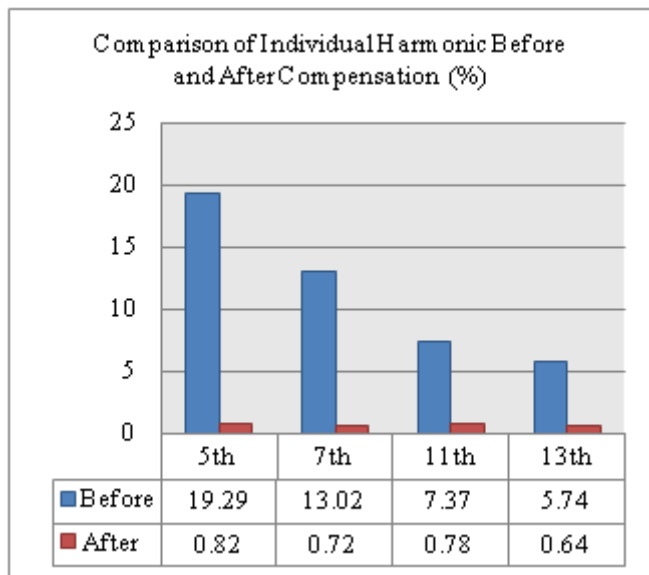

Fig. 15 Comparison of individual harmonics for Rectifier R-L load

Fig. 9 and Fig.14 shows the FFT analysis of source current for Rectifier R and Rectifier R-L load respectively. Fig. 10 and Fig. 15 show the comparison of individual harmonic before and after harmonic mitigation using shunt active power filter. Fig. 16 shows the comparison of overall mitigation in source current and after insertion of shunt active power filter.

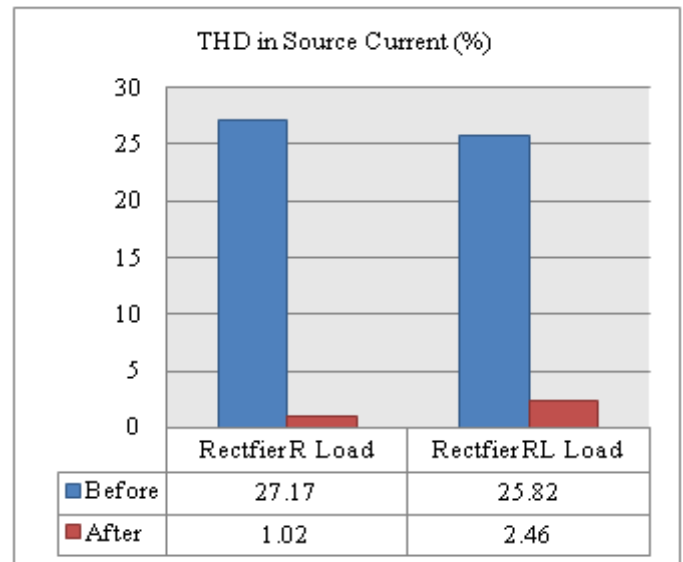

Fig. 16 Comparison of THD in source current

VI. CONCLUSION

In this paper the performance analysis of shunt active power filter using instantaneous reactive power theory have been carried out. Simulation results show the effectiveness of shunt active power filter for harmonic elimination in distorted source current. Two types of loads have been considered to check the validity and flexibility of the proposed scheme. In both the cases THD of source current reduces from 27.17 % to 1.02 % and 25.82 % to 2.46 %, which comply with IEEE-519 standard of harmonic control.

REFERENCES

- [1] H. Sasaki and T. Machida, "A New Method to Eliminate AC Harmonic by Magnetic Compensation Consideration on Basic Design," IEEE Trans. on Power Apparatus and Syst., vol. 90, no. 5, pp. 2009-2019.
- [2] H. Akagi, Y. Kanazawa, K. Fujita And A. Nabae "Generalized Theory of Instantaneous Reactive Power and Its Application" Electrical Engineering in Japan, Vol. 103, No. 4, 1983
- [3] H. Akagi "Control Strategy and Site Selection of a Shunt Active Filter for Damping of Harmonic propagation in Power Distribution Systems" IEEE Transactions on Power Delivery, Vol. 12, No 1, 1997
- [4] T. Narongrit, K-L. Areerak and K-N. Areerak "The Comparison Study of Current Control Techniques for Active Power Filters" 2011
- [5] H. Akagi "New Trends in Active Filter for Power Conditioning" IEEE Transactions On Industry Applications, Vol 32, No 6, 1996
- [6] H. Akagi, E. H. Watanabe, M. Aredes "Instantaneous Power Theory and Application to Power Conditioning" IEEE Press, 2007